

EXPORT EQUIPMENT CATALOGUE

**WHEEL BALANCERS
AND ORIGINAL ACCESSORIES
EFFECTIVE FROM JANUARY 2024**



automotive service equipment

REL. MAY 2024

Nexion SpA reserves the right to change the specifications of its products at any time without prior notice. The company declines all responsibility in the event of claims deriving from the use of non-original accessories or spare parts with consequent forfeiture of the EC declaration of conformity.

MONDOLFO FERRO

SUMMARY

| | |
|--|-----------|
| CAR WHEEL BALANCERS | 4 |
| MT3100UP - MT3200UP - MT3200UP PLUS | 4 |
| MT3200 C UP PLUS | 5 |
| MT3600UP | 6 |
| MT3600UP C | 7 |
| MT3350UP - MT3350CUP | 8 |
| MT3650UP - MT3650CUP | 9 |
| MT3650 UP TOUCHSCREEN - MT3650C UP TOUCHSCREEN | 10 |
| MT3500 UP - MT3500C UP LASER | 11 |
| MT3800 UP - MT3800C UP LASER | 12 |
| MT3800 UP - MT3800C UP TOUCHSCREEN | 13 |
| MT3900C UP LASER SCAN AUTOMATIC LOCKING | 14 |
| MT4000C UP DIAGNOSTIC | 15 |
| ACCESSORIES FOR CAR WHEEL BALANCERS | 16 |
| ACCESSORIES FOR WHEEL BALANCERS FOR MOTORBIKE | 35 |
| ACCESSORIES FOR MOTORBIKES WHEEL BALANCERS | 36 |
| | |
| WHEEL BALANCERS FOR "CAR MOBILE SERVICE" | 39 |
| MT3000 UP - TILT UP HAND SPIN | 39 |
| MT3000 UP VAN MOTORIZED SPIN | 40 |
| MT3000 UP WORKBENCH HAND SPIN | 41 |
| ACCESSORIES WHEEL BALANCERS FOR "CAR MOBILE SERVICE" | 42 |
| | |
| WHEEL BALANCERS FOR "TRUCK MOBILE SERVICE" | 44 |
| MT6310 MOBILE TRUCK | 44 |
| | |
| TRUCK WHEEL BALANCERS | 46 |
| MT2450 EASY-ALU | 46 |
| MT2650 EASY-ALU | 47 |
| MT6350 | 48 |
| ACCESSORIES FOR TRUCK WHEEL BALANCERS | 49 |

CAR WHEEL BALANCERS

MT3100UP - MT3200UP - MT3200UP PLUS

STANDARD ACCESSORIES

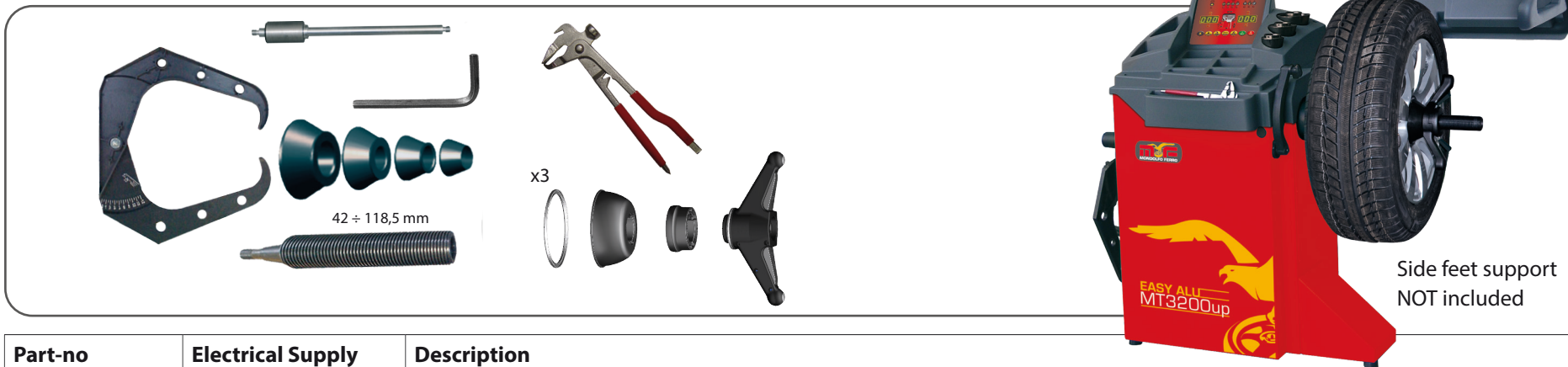

| Part-no | Electrical Supply | Description |
|---------------|-------------------|---|
| 0-21331000/16 | 200÷230V/1Ph/50Hz | MT3100up - LCD display machine with manual data input and automatic brake at the end of the spin (wheel guard included). |
| 0-21331001/16 | 110÷115V/1Ph/60Hz | As above, different power supply . |
| 0-21331002/16 | 200÷230V/1Ph/50Hz | MT3100up - LCD display machine with manual data input and automatic brake at the end of the spin (wheel guard NOT included) |
| 0-21331003/16 | 110÷115V/1Ph/60Hz | As above, different power supply |
| 0-21332000/16 | 200÷230V/1Ph/50Hz | MT3200up - LCD display machine with automatic data input and automatic brake at the end of the spin (wheel guard included). |
| 0-21332001/16 | 110÷115V/1Ph/60Hz | As above, different power supply . |
| 0-21332002/16 | 200÷230V/1Ph/50Hz | MT3200up - LCD display machine with automatic data input and automatic brake at the end of the spin (wheel guard NOT included). |
| 0-21332003/16 | 110÷115V/1Ph/60Hz | As above, different power supply . |
| 0-21332004/16 | 200÷230V/1Ph/50Hz | MT3200up PLUS - LCD display machine with automatic data input and automatic brake at the end of the spin, electrical brake & RPA (wheel guard included). |
| 0-21332005/16 | 110÷115V/1Ph/60Hz | As above, different power supply . |
| 0-21332006/16 | 200÷230V/1Ph/50Hz | MT3200up PLUS - LCD display machine with automatic data input and automatic brake at the end of the spin, electrical brake & RPA (wheel guard NOT included). |
| 0-21332007/16 | 110÷115V/1Ph/60Hz | As above, different power supply . |

CAR WHEEL BALANCERS

MT3200 C UP PLUS

STANDARD ACCESSORIES



Side feet support
NOT included

| Part-no | Electrical Supply | Description | |
|---------------|----------------------|---|--|
| 0-21332008/16 | 200-230V/1Ph/50-60Hz | MT3200-C UP PLUS LCD display wheel balancer with automatic data input and automatic brake at the end of the spin, automatic wheel clamping, AWC Auto Width Calculation, automatic brake at the end of the measurement and RPA system | |
| 0-21332009/16 | 100-115V/1Ph/50-60Hz | As above, but with different power supply | |

CAR WHEEL BALANCERS

MT3600UP

STANDARD ACCESSORIES

Monitor not included



Side feet support
NOT included



| Part-no | Electrical Supply | Description |
|---------------|-------------------|--|
| 0-21336000/16 | 200÷230V/1Ph/50Hz | MT3600up - Machine with automatic data input, automatic brake at the end of the spin, RPA system; Easy Weight program (monitor NOT included). |
| 0-21336001/16 | 110÷115V/1Ph/60Hz | As above, but with different power supply . |
| 0-21336002/16 | 200÷230V/1Ph/50Hz | MT3600up - Machine with automatic data input, automatic brake at the end of the spin, RPA system (monitor and wheel guard NOT included), Easy Weight program. |
| 0-21336003/16 | 110÷115V/1Ph/60Hz | As above, but with different power supply . |

CAR WHEEL BALANCERS

MT3600UP C

STANDARD ACCESSORIES



Monitor and pl50 not included

| Part-no | Electrical Supply | Description |
|---------------|----------------------|--|
| 0-21336004/16 | 200-230V/1Ph/50Hz | MT3600up C - Wheel balancer, compact and essential with professional performances; Pneumatic wheel clamping (patent). Easy & Quick to use; Automatic wheel distance and diameter acquisition with AUTOSELECT for the automatic identification of the best balancing program;AWC (Auto Width Calculation): automatic calculation of the width even if the TL-3 external sensor is not present. The wheel balancer calculates the width by reducing the operational time;Automatic braking at end of measurement; Rpa system - research of the weight automation position and automatic clamping brake;Quick optimise, Hidden weight and Split weight programmes for motorcycles; 4 cones (42÷118,5mm); Monitor and PL50 not included |
| 0-21336005/16 | 110÷115V/1Ph/50-60Hz | As above, but with different power supply. |

CAR WHEEL BALANCERS

MT3350UP - MT3350CUP

STANDARD ACCESSORIES

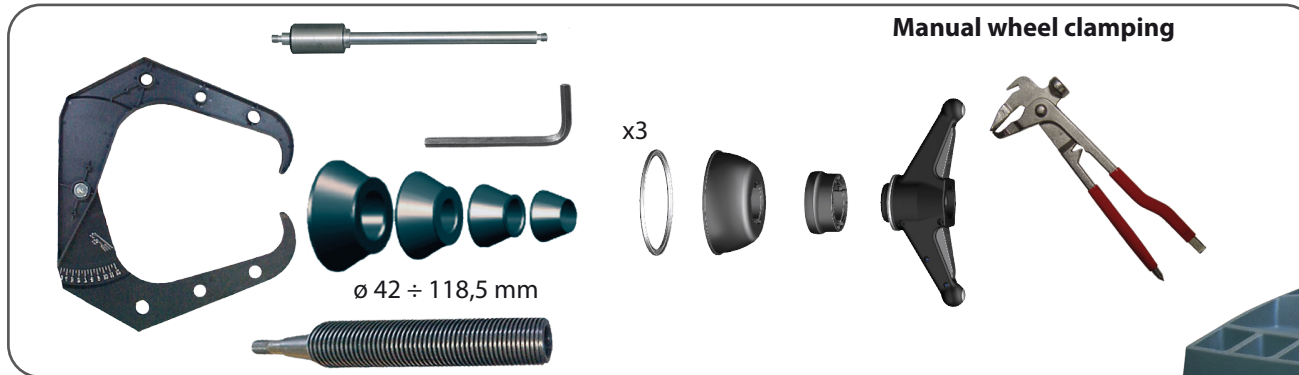

STANDARD ACCESSORIES



| Part-no | Electrical Supply | Description |
|---------------|-------------------|--|
| 0-21333500/16 | 200÷230V/1Ph/50Hz | MT3350 UP - Professional wheel balancer for cars, lightweight transport vehicles and motor vehicles; double display control panel; Laser, spotlight, speed and ease of use; automatic data acquisition, electrical brake, laser & LED, wheel guard |
| 0-21333501/16 | 110÷115V/1Ph/60Hz | As above, but with different power supply . |
| 0-21333502/16 | 200÷230V/1Ph/50Hz | MT3350-C UP - Professional wheel balancer for cars, lightweight transport vehicles and motor vehicles; new automatic wheel clamping system; double display control panel; Laser, spotlight, speed and ease of use; automatic data acquisition, electrical brake, laser & LED, wheel guard |
| 0-21333503/16 | 110÷115V/1Ph/60Hz | As above, but with different power supply . |

CAR WHEEL BALANCERS

MT3650UP - MT3650CUP

STANDARD ACCESSORIES

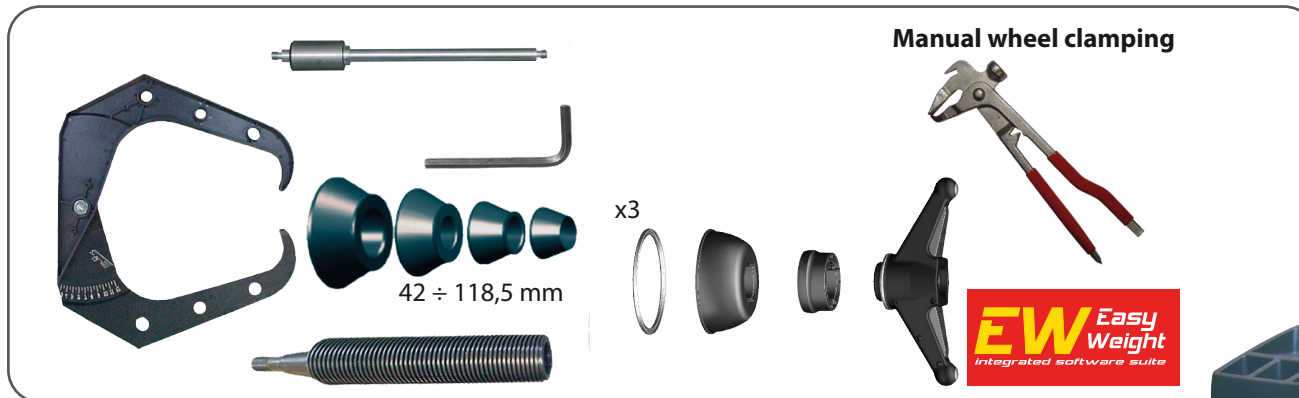

STANDARD ACCESSORIES



Monitor not included



| Part-no | Electrical Supply | Description |
|---------------|-------------------|--|
| 0-21336500/16 | 200÷230V/1Ph/50Hz | MT3650 up - Machine with LaserLine indicator, automatic data input (monitor NOT included), Easy Weight program. |
| 0-21336501/16 | 110÷115V/1Ph/60Hz | As above, but with different power supply . |
| 0-21336502/16 | 200÷230V/1Ph/50Hz | MT3650C up - Machine with automatic wheel clamping, LaserLine indicator, automatic data input , Easy Weight program (monitor NOT included). |
| 0-21336503/16 | 110÷115V/1Ph/60Hz | As above, but with different power supply . |

CAR WHEEL BALANCERS

MT3650 UP TOUCHSCREEN - MT3650C UP TOUCHSCREEN

STANDARD ACCESSORIES

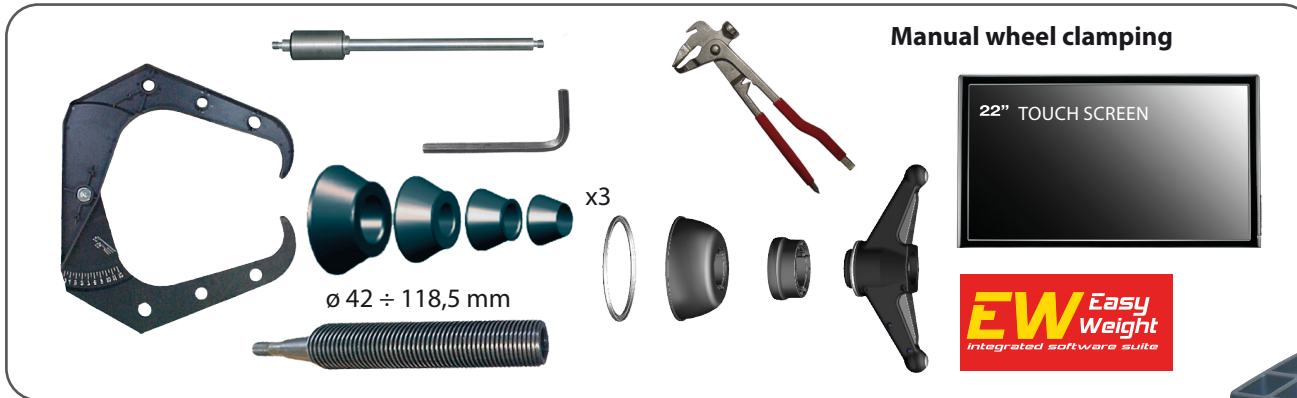

STANDARD ACCESSORIES



| Part-no | Electrical Supply | Description | |
|---------------|-------------------|--|--|
| 0-21336504/16 | 200÷230V/1Ph/50Hz | MT3650 up Touchscreen - Machine with manual wheel clamping, LaserLine indicator, automatic data input, electronic braking and automatic positioning, Easy Weight program. TL3 for touchless width measurement NOT included. | |
| 0-21336505/16 | 200÷230V/1Ph/50Hz | MT3650C up Touchscreen - Machine with automatic wheel clamping, LaserLine indicator, automatic data input, electronic braking and automatic positioning, Easy Weight program. TL3 for touchless width measurement NOT included. | |

CAR WHEEL BALANCERS

MT3500 UP - MT3500C UP LASER

STANDARD ACCESSORIES

Manual wheel clamping

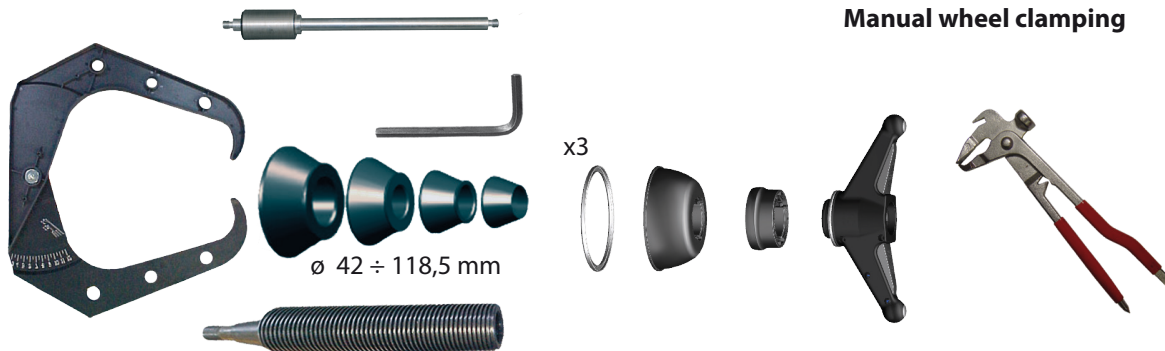

STANDARD ACCESSORIES

Automatic wheel clamping (C Version)

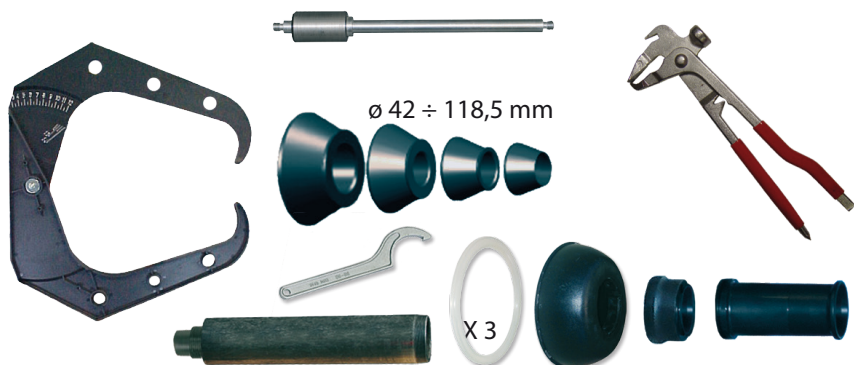

MT3500 up Version

| Part-no | Electrical Supply | Description |
|---------------|----------------------|--|
| 0-21335006/16 | 100-230V/1Ph/50-60Hz | MT3500C up Laser High performance wheel balancer with LCD Display and LaserLine indicator, automatic wheel clamping, automatic data input with Auto Select Program, "Zero Space" wheel guard (automatic sensor not included) |
| 0-21335007/16 | 100-230V/1Ph/50-60Hz | MT3500 up Laser - As above but with manual wheel clamping. |

CAR WHEEL BALANCERS

MT3800 UP - MT3800C UP LASER

STANDARD ACCESSORIES

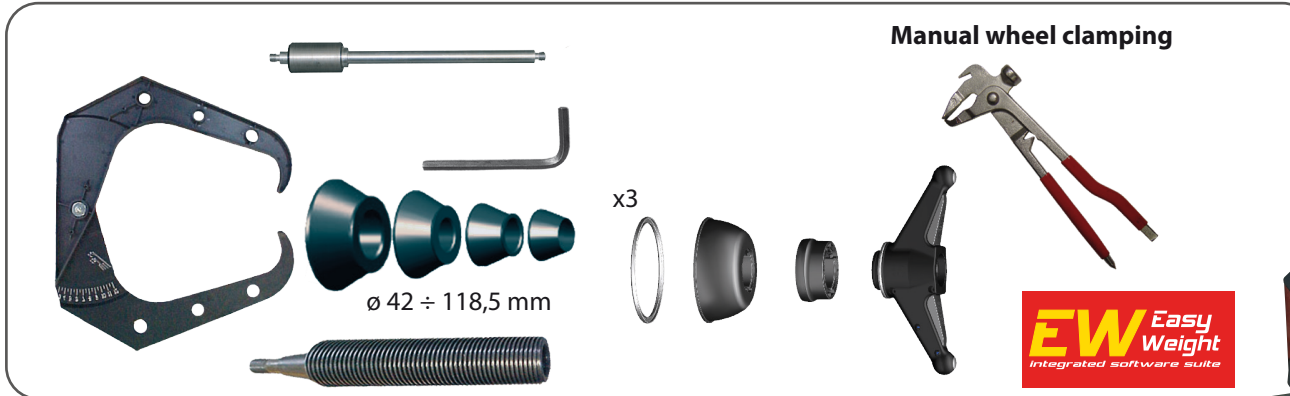

STANDARD ACCESSORIES



| Part-no | Electrical Supply | Description | |
|---------------|----------------------|--|--|
| 0-21338006/16 | 100-230V/1Ph/50-60Hz | MT3800C up Laser - High performance wheel balancer with LaserLine indicator, automatic wheel clamping, automatic data input with Auto Select Program, "Zero Space" wheel guard (monitor and automatic sensor not included) | |
| 0-21338007/16 | 100-230V/1Ph/50-60Hz | MT3800 up Laser - As above but with manual wheel clamping. | |

CAR WHEEL BALANCERS

MT3800 UP TOUCHSCREEN - MT3800C UP TOUCHSCREEN

STANDARD ACCESSORIES



Monitor included

STANDARD ACCESSORIES



MT3800 up C Version

| Part-no | Electrical Supply | Description |
|---------------|----------------------|---|
| 0-21338011/16 | 100-230V/1Ph/50-60Hz | MT3800C up Touchscreen - Wheel balancer with 22" industrial Touchscreen monitor, Laser Line system, Led illuminator, AUTOSELECT UP device for automatic program selection, LaserPlane function, exclusive Wireless locking device (WINUT), automatic wheel clamping, space saving wheel guard, Easy Weight program included (Sonar and Run-Out kit NOT included) |
| 0-21338010/16 | 100-230V/1Ph/50-60Hz | MT3800 up Touchscreen - As above but with manual wheel clamping. |

CAR WHEEL BALANCERS

MT3900C UP LASER SCAN AUTOMATIC LOCKING

STANDARD ACCESSORIES



Monitor included

| Part-no | Electrical Supply | Description |
|---------------|----------------------|--|
| 0-21339000/16 | 100-230V/1Ph/50-60Hz | MT3900C UP laser scan Automatic locking Touch screen machine for tyre assistance centres, dealerships, workshops and car manufacturers dealing with large volumes; no-contact data input (LASER-SONAR compined system) ; 22" touchscreen monitor ; automatic electromechanical wheel clamping system; Easy Weight program included; Zero-Space wheel guard; punctiform laser. |

CAR WHEEL BALANCERS

MT4000C UP DIAGNOSTIC

STANDARD ACCESSORIES





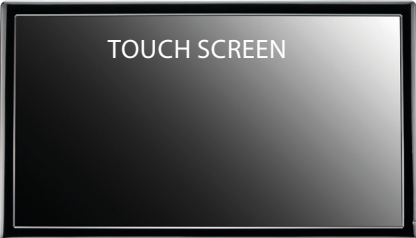

Automatic wheel clamping



Monitor incluso

| Part-no | Electrical Supply | Description | |
|---------------|----------------------|---|--|
| 0-21340010/16 | 100-230V/1Ph/50-60Hz | MT4000C up diagnostic Automatic wheel balancer; 22" touchscreen monitor; Laser pointer; automatic data acquisition; automatic wheel clamping; automatic braking at the end of measurement; Zero-Space wheel guard; Easy Weight program included. | |

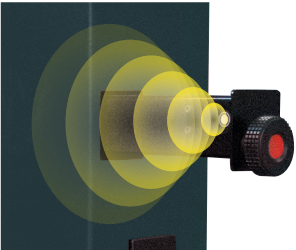

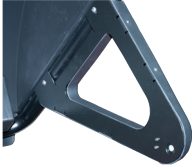
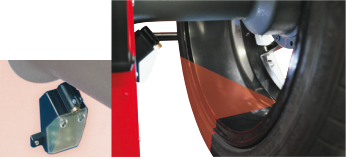
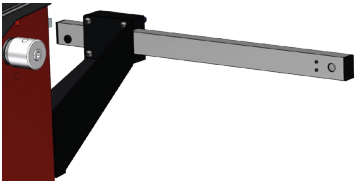

ACCESSORIES FOR CAR WHEEL BALANCERS

| Image | Part-no | Description | | MT 3100up | MT 3200up | MT 3200up PLUS | MT 3200C up PLUS | MT 3350up | MT 3350 C up | MT 3600up | MT 3600 C up | MT 3650up | MT 3650 C up | MT 3650up Touchscr | MT 3650 C up Touchscr | MT 3500 up | MT 3500 C up | MT 3800 up | MT 3800 C up | MT 3800 up Touchscr. | MT 3800 C up Touchscr | MT 3900C UP | MT 4000 C UP | | |
|---|------------|---|--|-----------|-----------|----------------|------------------|-----------|--------------|-----------|--------------|-----------|--------------|--------------------|-----------------------|------------|--------------|------------|--------------|----------------------|-----------------------|-------------|--------------|--|--|
| ELECTRONIC DEVICE | | | | | | | | | | | | | | | | | | | | | | | | | |
|  | 8-21120022 | LASER PLANE KIT: Upgrade kit to guide the operator in choosing the rim's inner planes without any errors and with extremely good visibility | | | ★ | ★ | ★ | ★ | ★ | ★ | ★ | ★ | ★ | ★ | ★ | | | | | | | | | | |
|  | 8-21120023 | Upgrade LASER PLANE kit for MT3500 and MT3800 series, not UP version (this kit is already fitted on the MT3500 and MT3800 Laser UP series, it allows the upgrade of the MT3500 and MT3800 models not UP version, manufactured until end of 2017) | | | | | | | | | | | | | | | □ | □ | □ | □ | □ | □ | | | |
|  | 8-21100250 | RRS Sonar RUN-OUT Kit for measuring wheel eccentricity. In touchscreen models, in addition to graphical data visualization, the BESTFIT function is also included. | | | | | | | | | | | | | | | | | ★ | ★ | ★ | ★ | ★ | | |
|  | 8-21100074 | TL2 - External width gauge for automatic data entry of wheel width. | | | ★ | | | | | | | | | | | | | | | | | | | | |





ACCESSORIES FOR CAR WHEEL BALANCERS

| Image | Part-no | Description | MT 3100up | MT 3200up | MT 3200up PLUS | MT 3200C up PLUS | MT 3350up | MT 3350 C up | MT 3600up | MT 3600 C up | MT 3650up | MT 3650 C up | MT 3650up Touchscr | MT 3650 C up Touchscr | MT 3500 up | MT 3500 C up | MT 3800 up | MT 3800 C up | MT 3800 up Touchscr. | MT 3800 C up Touchscr | MT 3900C UP | MT 4000 C UP |
|---|------------|--|-----------|-----------|----------------|------------------|-----------|--------------|-----------|--------------|-----------|--------------|--------------------|-----------------------|------------|--------------|------------|--------------|----------------------|-----------------------|-------------|--------------|
|  | 8-21100232 | TL3 - Sonar device for measure the width | | | ★ | ★ | ★ | ★ | ★ | ★ | ★ | ★ | ★ | ★ | ★ | ★ | ★ | ★ | ★ | ★ | □ | □ |
|  | 8-21100238 | Laser & Led kit. | ★ | ★ | ★ | ★ | □ | □ | ★ | ★ | □ | □ | □ | □ | | | | | | | | |
|  | 8-21100277 | RRS-2 Sonar RUN-OUT Kit allows you to check the status of wheel eccentricity through a system of colored icons on the main screen. | | | | | | | ★ | ★ | ★ | ★ | ★ | ★ | | | | | | | | |





ACCESSORIES FOR CAR WHEEL BALANCERS

| Image | Part-no | Description | MT 3100up | MT 3200up | MT 3200up PLUS | MT 3200C up PLUS | MT 3350up | MT 3350 C up | MT 3600up | MT 3600 C up | MT 3650up | MT 3650 C up | MT 3650up Touchscr | MT 3650 C up Touchscr | MT 3500 up | MT 3500 C up | MT 3800 up | MT 3800 C up | MT 3800 up Touchscr. | MT 3800 C up Touchscr | MT 3900C UP | MT 4000 C UP | |
|---|---------------|---|-----------|-----------|----------------|------------------|-----------|--------------|-----------|--------------|-----------|--------------|--------------------|-----------------------|------------|--------------|------------|--------------|----------------------|-----------------------|-------------|--------------|---|
| VARIOUS AND CUSTOMIZATION KITS | | | | | | | | | | | | | | | | | | | | | | | |
|  LAN CONNECTION KIT | 8-21100255 | LAN CONNECTION KIT Interconnection kit of the wheel balancer to the company management system network; it allow to view, archive and print remotely the different measurement and diagnostic reports of the diagnostic wheel balancer. | | | | | | | | ★ | ★ | ★ | ★ | ★ | ★ | | | ★ | ★ | ★ | ★ | ★ | ★ |
|  | 8-21100253/16 | Support panel for HPC High Precision Collets centering kit, painted in red color (for MT3350 UP, MT3500 UP, MT3800 UP series and MT3900-C UP and MT4000-C UP painted in red color RAL 3002 in /16) | | | | | | | | | | | | | ★ | ★ | ★ | ★ | ★ | ★ | ★ | ★ | ★ |
| | 8-21100253/64 | Support panel for HPC High Precision Collets centering kit painter in dark grey (for MT3350 UP, MT3500 UP, MT3800 UP series and MT3900-C UP anchd MT4000-C UP painted in other colors, NOT RAL 3002 in /16) | | | | | | | | | | | | | ★ | ★ | ★ | ★ | ★ | ★ | ★ | ★ | ★ |
|  | 8-21100159 | CLIP - Clip for adhesive weight | ★ | ★ | ★ | ★ | ★ | ★ | ★ | ★ | ★ | ★ | ★ | ★ | | | | | | | | | |
|  | 8-21100158/16 | PL50 - Side feet support (RED COLOR) | ★ | ★ | ★ | ★ | | | ★ | ★ | | | | | | | | | | | | | |
| | 8-21100158/90 | PL50 - Side feet support (BLACK COLOR) | ★ | ★ | ★ | ★ | | | ★ | ★ | | | | | | | | | | | | | |

ACCESSORIES FOR CAR WHEEL BALANCERS

| Image | Part-no | Description | MT 3100up | MT 3200up | MT 3200up PLUS | MT 3200C up PLUS | MT 3350up | MT 3350 C up | MT 3600up | MT 3600 C up | MT 3650up | MT 3650 C up | MT 3650up Touchscr | MT 3650 C up Touchscr | MT 3500 up | MT 3500 C up | MT 3800 up | MT 3800 C up | MT 3800 up Touchscr. | MT 3800 C up Touchscr | MT 3900C UP | MT 4000 C UP | |
|---|---------------|--|-----------|-----------|----------------|------------------|-----------|--------------|-----------|--------------|-----------|--------------|--------------------|-----------------------|------------|--------------|------------|--------------|----------------------|-----------------------|-------------|--------------|---|
|  | 8-21100258/16 | Side support panel: accessory holder support panel for centering kits and HPC kits, painted in red color (for wheel balancers already painted in red color RAL 3002 - /16) | ★ | ★ | ★ | ★ | | | ★ | ★ | | | | | | | | | | | | | |
| | 8-21100258/64 | Side support panel: accessory holder support panel for centering kits and HPC kits, painted in dark grey color (for wheel balancers already painted in other colors, NOT RAL 3002 - /16) | ★ | ★ | ★ | ★ | | | ★ | ★ | | | | | | | | | | | | | |
|  | 8-21100191 | CB - Pedal brake | ★ | ★ | | | | | | | | | | | | | | | | | | | |
|  | 8-21100251 | DISPENSER KIT: easy-to-use dispenser kit for adhesive counterweights coil | ★ | ★ | ★ | ★ | ★ | ★ | ★ | ★ | ★ | ★ | ★ | ★ | ★ | ★ | ★ | ★ | ★ | ★ | ★ | ★ | ★ |
| | 8-21100252 | Adhesive counterweights coil: metal coil 5 gr x 1200 - 6 kg | ★ | ★ | ★ | ★ | ★ | ★ | ★ | ★ | ★ | ★ | ★ | ★ | ★ | ★ | ★ | ★ | ★ | ★ | ★ | ★ | ★ |
|  | 8-21100292/90 | VC - Voltage Converter 220V to 110V Voltage converter to electrically connect a 110V wheel balancer to a 220V mains voltage. Only for markets that have dual 220V and 110V mains power supplies and for wheel balancers manufactured in 110V. | ★ | ★ | ★ | ★ | ★ | ★ | ★ | ★ | ★ | ★ | ★ | ★ | | | | | | | | | |



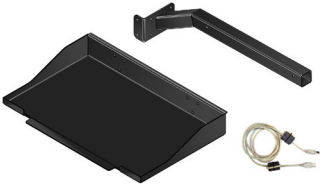

ACCESSORIES FOR CAR WHEEL BALANCERS

| Image | Part-no | Description | MT 3100up | MT 3200up | MT 3200up PLUS | MT 3200C up PLUS | MT 3350up | MT 3350 C up | MT 3600up | MT 3600 C up | MT 3650up | MT 3650 C up | MT 3650up Touchscr | MT 3650 C up Touchscr | MT 3500 up | MT 3500 C up | MT 3800 up | MT 3800 C up | MT 3800 up Touchscr. | MT 3800 C up Touchscr | MT 3900C UP | MT 4000 C UP | |
|---|---------------|--------------------------|-----------|-----------|----------------|------------------|-----------|--------------|-----------|--------------|-----------|--------------|--------------------|-----------------------|------------|--------------|------------|--------------|----------------------|-----------------------|-------------|--------------|---|
| MONITORS AND PRINTER | | | | | | | | | | | | | | | | | | | | | | | |
|  | 8-21100235 | 19" Wide screen monitor. | | | | | | | ★ | ★ | ★ | ★ | | | | | | ★ | ★ | | | | |
|  | 8-21100234 | 22" Wide screen monitor. | | | | | | | | | ★ | ★ | | | | | | ★ | ★ | | | | |
|  | 8-21120006 | Cleaning kit for monitor | | | | | | | ★ | ★ | ★ | ★ | ★ | ★ | | | | ★ | ★ | ★ | ★ | ★ | ★ |
|  | 8-21120005 | USB inkjet printer unit | | | | | | | | | | | | | | | | | | ★ | ★ | ★ | ★ |
|  | 8-21200002/90 | Printer support kit | | | | | | | | | | | | | | | | | | ★ | ★ | ★ | ★ |

ACCESSORIES FOR CAR WHEEL BALANCERS

| Image | Part-no | Description | MT 3100up | MT 3200up | MT 3200up PLUS | MT 3200C up PLUS | MT 3350up | MT 3350 C up | MT 3600up | MT 3600 C up | MT 3650up | MT 3650 C up | MT 3650up Touchscr | MT 3650 C up Touchscr | MT 3500 up | MT 3500 C up | MT 3800 up | MT 3800 C up | MT 3800 up Touchscr. | MT 3800 C up Touchscr | MT 3900C UP | MT 4000 CUP |
|---------------------------|--------------|---|--------------------------|--------------------------|--------------------------|--------------------------|--------------------------|--------------------------|--------------------------|--------------------------|--------------------------|--------------------------|--------------------------|--------------------------|--------------------------|--------------------------|--------------------------|--------------------------|--------------------------|--------------------------|--------------------------|--------------------------|
| CENTERING ADAPTORS | | | | | | | | | | | | | | | | | | | | | | |
| | 8-21100289 | GBP40 EVO KIT - Professional quick nut kit ø40x3mm: | <input type="checkbox"/> | <input type="checkbox"/> | <input type="checkbox"/> | <input type="checkbox"/> | <input type="checkbox"/> | <input type="checkbox"/> | <input type="checkbox"/> | <input type="checkbox"/> | <input type="checkbox"/> | <input type="checkbox"/> | <input type="checkbox"/> | <input type="checkbox"/> | <input type="checkbox"/> | <input type="checkbox"/> | <input type="checkbox"/> | <input type="checkbox"/> | <input type="checkbox"/> | <input type="checkbox"/> | <input type="checkbox"/> | <input type="checkbox"/> |
| | 4-115868 | PCF1 - Wheel protector for centering alloy rims | | | | | | | | | | | | | | | | | | | | |
| | 4-115863 | CF1 - Wheel clamping cap | | | | | | | | | | | | | | | | | | | | |
| | 4-115864 | CD1 - Spacer cap | | | | | | | | | | | | | | | | | | | | |
| | 5-101561 | GBP EVO - Quick nut | | | | | | | | | | | | | | | | | | | | |
| | 4-104798 | GBP1 - Clamp "R" | | | | | | | | | | | | | | | | | | | | |
| | 4-104799 | GBP2 - Clamp "L" | | | | | | | | | | | | | | | | | | | | |
| 4-104796 | GBP3 - Lever | | | | | | | | | | | | | | | | | | | | | |
| | 8-21100280 | CCK3 EVO KIT - Centering cone kit ø40mm 42÷103,5mm: | <input type="checkbox"/> | <input type="checkbox"/> | <input type="checkbox"/> | <input type="checkbox"/> | <input type="checkbox"/> | <input type="checkbox"/> | <input type="checkbox"/> | <input type="checkbox"/> | <input type="checkbox"/> | <input type="checkbox"/> | <input type="checkbox"/> | <input type="checkbox"/> | <input type="checkbox"/> | <input type="checkbox"/> | <input type="checkbox"/> | <input type="checkbox"/> | <input type="checkbox"/> | <input type="checkbox"/> | <input type="checkbox"/> | <input type="checkbox"/> |
| | 5-107970 | CP1 - Small cone ø42÷68 mm | | | | | | | | | | | | | | | | | | | | |
| | 5-107968 | CP2 - Medium cone ø60÷87 mm | | | | | | | | | | | | | | | | | | | | |
| | 5-107971 | CP3 - Large cone ø83÷103 mm | | | | | | | | | | | | | | | | | | | | |
| | 8-21100283 | MFS Standard Threaded Shaft Ø40x3mm – 181,5 mm long | ★ | ★ | ★ | | ★ | ★ | ★ | ★ | ★ | ★ | ★ | ★ | ★ | ★ | ★ | ★ | ★ | | | |
| | 8-21100193 | MFL - XL threaded shaft ø40x3mm - 220mm long | ★ | ★ | ★ | | ★ | ★ | ★ | ★ | ★ | ★ | ★ | ★ | ★ | ★ | ★ | ★ | ★ | | | |
| | 8-21100285 | MBP40 EVO KIT -Locking sleeve kit for electric or pneumatic wheel locking system: | | | | <input type="checkbox"/> | <input type="checkbox"/> | <input type="checkbox"/> | <input type="checkbox"/> | <input type="checkbox"/> | <input type="checkbox"/> | <input type="checkbox"/> | <input type="checkbox"/> | <input type="checkbox"/> | <input type="checkbox"/> | <input type="checkbox"/> | <input type="checkbox"/> | <input type="checkbox"/> | <input type="checkbox"/> | <input type="checkbox"/> | <input type="checkbox"/> | <input type="checkbox"/> |
| | 4-115868 | PCF1 - Wheel protector for centering alloy rims | | | | | | | | | | | | | | | | | | | | |
| | 4-115863 | CF1 - Wheel clamping cap | | | | | | | | | | | | | | | | | | | | |
| | 4-115864 | CD1 - Spacer cap | | | | | | | | | | | | | | | | | | | | |
| | 5-107394 | QLS - Quick Locking Sleeve | | | | | | | | | | | | | | | | | | | | |

ACCESSORIES FOR CAR WHEEL BALANCERS

| Image | Part-no | Description | MT 3100up | MT 3200up | MT 3200up PLUS | MT 3200C up PLUS | MT 3350up | MT 3350 C up | MT 3600up | MT 3600 C up | MT 3650up | MT 3650 C up | MT 3650up Touchscr | MT 3650 C up Touchscr | MT 3500 up | MT 3500 C up | MT 3800 up | MT 3800 C up | MT 3800 up Touchscr. | MT 3800 C up Touchscr | MT 3900C UP | MT 4000 C UP |
|---|---------------|---|-----------|-----------|----------------|------------------|-----------|--------------|-----------|--------------|-----------|--------------|--------------------|-----------------------|------------|--------------|------------|--------------|----------------------|-----------------------|-------------|--------------|
| CENTERING ADAPTORS | | | | | | | | | | | | | | | | | | | | | | |
|  | 802260682 | VGBP Hand wheel for wheel fastener ring. | ★ | ★ | ★ | | ★ | | ★ | | ★ | | ★ | | ★ | | ★ | | ★ | | | |
|  | 8-21100291 | Kit with 2 revolving knob | ★ | ★ | ★ | | ★ | | ★ | | ★ | | ★ | | ★ | | ★ | | ★ | | | |
|  | 8-21100244 | HPC - High Precision Collets centering kit. | ★ | ★ | ★ | ★ | ★ | ★ | ★ | ★ | ★ | ★ | ★ | ★ | ★ | ★ | ★ | ★ | ★ | ★ | ★ | ★ |
|  | 8-21100243/90 | Trolley for HPC kit. | ★ | ★ | ★ | ★ | ★ | ★ | ★ | ★ | ★ | ★ | ★ | ★ | ★ | ★ | ★ | ★ | ★ | ★ | ★ | ★ |



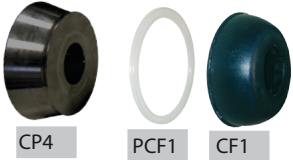
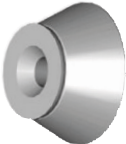

ACCESSORIES FOR CAR WHEEL BALANCERS

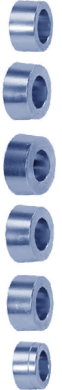
| Image | Part-no | Description | MT 3100up | MT 3200up | MT 3200up PLUS | MT 3200C up PLUS | MT 3350up | MT 3350 C up | MT 3600up | MT 3600 C up | MT 3650up | MT 3650 C up | MT 3650up Touchscr | MT 3650 C up Touchscr | MT 3500 up | MT 3500 C up | MT 3800 up | MT 3800 C up | MT 3800 up Touchscr. | MT 3800 C up Touchscr | MT 3900C UP | MT 4000 C UP |
|---|------------|---|--------------------------|--------------------------|--------------------------|--------------------------|--------------------------|--------------------------|--------------------------|--------------------------|--------------------------|--------------------------|--------------------------|--------------------------|--------------------------|--------------------------|--------------------------|--------------------------|--------------------------|--------------------------|--------------------------|--------------------------|
| CENTERING ADAPTORS | | | | | | | | | | | | | | | | | | | | | | |
|  CP4 PCF1 CF1 | 8-21100080 | ARF Accessory for off-road wheels Ø 100 ÷118,5 mm, Ø 100 ÷129,5 mm | <input type="checkbox"/> | <input type="checkbox"/> | <input type="checkbox"/> | <input type="checkbox"/> | <input type="checkbox"/> | <input type="checkbox"/> | <input type="checkbox"/> | <input type="checkbox"/> | <input type="checkbox"/> | <input type="checkbox"/> | <input type="checkbox"/> | <input type="checkbox"/> | <input type="checkbox"/> | <input type="checkbox"/> | <input type="checkbox"/> | <input type="checkbox"/> | <input type="checkbox"/> | <input type="checkbox"/> | <input type="checkbox"/> | <input type="checkbox"/> |
| | 4-103186 | CGF - Off-road wheel cone (vans) | | | | | | | | | | | | | | | | | | | | |
| | 4-115868 | PCF1 - Wheel protector for centring alloy rims | | | | | | | | | | | | | | | | | | | | |
| | 4-115863 | CF1 - Wheel clamping cap | | | | | | | | | | | | | | | | | | | | |
|  | 8-21100096 | Centering cone capacity from Ø95 to Ø137 mm. | ★ | ★ | ★ | ★ | ★ | ★ | ★ | ★ | ★ | ★ | ★ | ★ | ★ | ★ | ★ | ★ | ★ | ★ | ★ | ★ |

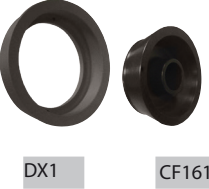

ACCESSORIES FOR CAR WHEEL BALANCERS

| Image | Part-no | Description | MT 3100up | MT 3200up | MT 3200up PLUS | MT 3200C up PLUS | MT 3350up | MT 3350 C up | MT 3600up | MT 3600 C up | MT 3650up | MT 3650 C up | MT 3650up Touchscr | MT 3650 C up Touchscr | MT 3500 up | MT 3500 C up | MT 3800 up | MT 3800 C up | MT 3800 up Touchscr. | MT 3800 C up Touchscr | MT 3900C UP | MT 4000 C UP | |
|---|------------|--|-----------|-----------|----------------|------------------|-----------|--------------|-----------|--------------|-----------|--------------|--------------------|-----------------------|------------|--------------|------------|--------------|----------------------|-----------------------|-------------|--------------|--|
| CENTERING ADAPTORS | | | | | | | | | | | | | | | | | | | | | | | |
|  <ul style="list-style-type: none"> B1 ø 56,6÷57,1 mm B2 ø 65÷67 mm B3 ø 73,2÷75,4 mm B4 ø 63,3÷64,2 mm B5 ø 58÷60,1 mm B7 ø 54÷56,1 mm | 8-21100082 | SBC - Set of six centring bushes ø 40 | ★ | ★ | ★ | ★ | ★ | ★ | ★ | ★ | ★ | ★ | ★ | ★ | ★ | ★ | ★ | ★ | ★ | ★ | ★ | ★ | |
| | 4-105075 | B1 - Smart (Mercedes), SEAT, Chevrolet, Fiat (Grande Punto), Opel, Audi, Skoda, VW | | | | | | | | | | | | | | | | | | | | | |
| | 4-105076 | B2 - Citroen, Fiat (Scudo), Ford (Transit), Opel, Peugeot, Saab, Volvo, VW, Nissan, Audi (A4), Mercedes, Hyundai, Kia, Mazda, Mitsubishi | | | | | | | | | | | | | | | | | | | | | |
| | 4-105077 | B3 - Aston Martin, BMW (X5, X6), Suzuki (Carry), Jaguar | | | | | | | | | | | | | | | | | | | | | |
| | 4-105078 | B4 - Ford, Jaguar, Mazda (121, Mazda 2), Volvo, Honda, Alfa Romeo | | | | | | | | | | | | | | | | | | | | | |
| | 4-105079 | B5 - Alfa Romeo, Citroen, Fiat, Lancia, Peugeot, Lada, Nissan, Dacia, Renault, Subaru, Toyota | | | | | | | | | | | | | | | | | | | | | |
| | 4-105080 | B7 - Citroen (C1), Daihatsu, Hyundai, Kia, Mazda, Opel (Agila), Peugeot (106, 107), Subaru, Suzuki, Toyota, Honda, Mini (BMW), Proton | | | | | | | | | | | | | | | | | | | | | |

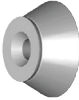

ACCESSORIES FOR CAR WHEEL BALANCERS

| Image | Part-no | Description | MT 3100up | MT 3200up | MT 3200up PLUS | MT 3200C up PLUS | MT 3350up | MT 3350 C up | MT 3600up | MT 3600 C up | MT 3650up | MT 3650 C up | MT 3650up Touchscr | MT 3650 C up Touchscr | MT 3500 up | MT 3500 C up | MT 3800 up | MT 3800 C up | MT 3800 up Touchscr. | MT 3800 C up Touchscr | MT 3900C UP | MT 4000 C UP |
|---|------------|---|-----------|-----------|----------------|------------------|-----------|--------------|-----------|--------------|-----------|--------------|--------------------|-----------------------|------------|--------------|------------|--------------|----------------------|-----------------------|-------------|--------------|
| CENTERING ADAPTORS | | | | | | | | | | | | | | | | | | | | | | |
|  | 8-21100083 | B6 - "Racing" bush for Ferrari/Maserati Ø 67 mm | ★ | ★ | ★ | ★ | ★ | ★ | ★ | ★ | ★ | ★ | ★ | ★ | ★ | ★ | ★ | ★ | ★ | ★ | ★ | ★ |
|  | 8-21100085 | B9 - Bush OPEL Ø 56,5-65-70,1 mm | ★ | ★ | ★ | ★ | ★ | ★ | ★ | ★ | ★ | ★ | ★ | ★ | ★ | ★ | ★ | ★ | ★ | ★ | ★ | ★ |
|  | 8-21120004 | DX1-CF161 - Professional centring kits for Mercedes Benz Sprinter and Volkswagen Crafter commercial vehicles with 161mm Ø central hole | ★ | ★ | ★ | ★ | ★ | ★ | ★ | ★ | ★ | ★ | ★ | ★ | ★ | ★ | ★ | ★ | ★ | ★ | ★ | ★ |
|  | 8-21100200 | CIP - Intermediate cone Ø 55÷72 mm | ★ | ★ | ★ | ★ | ★ | ★ | ★ | ★ | ★ | ★ | ★ | ★ | ★ | ★ | ★ | ★ | ★ | ★ | ★ | ★ |
|  | 19131018 | Cone for off-the-road wheels Ø 40 mm (88÷132 mm) | ★ | ★ | ★ | ★ | ★ | ★ | ★ | ★ | ★ | ★ | ★ | ★ | ★ | ★ | ★ | ★ | ★ | ★ | ★ | ★ |

















ACCESSORIES FOR CAR WHEEL BALANCERS

| Image | Part-no | Description | MT 3100up | MT 3200up | MT 3200up PLUS | MT 3200C up PLUS | MT 3350up | MT 3350 C up | MT 3600up | MT 3600 C up | MT 3650up | MT 3650 C up | MT 3650up Touchscr | MT 3650 C up Touchscr | MT 3500 up | MT 3500 C up | MT 3800 up | MT 3800 C up | MT 3800 up Touchscr. | MT 3800 C up Touchscr | MT 3900C UP | MT 4000 C UP |
|---|------------|--|-----------|-----------|----------------|------------------|-----------|--------------|-----------|--------------|-----------|--------------|--------------------|-----------------------|------------|--------------|------------|--------------|----------------------|-----------------------|-------------|--------------|
| CENTERING ADAPTORS | | | | | | | | | | | | | | | | | | | | | | |
|  DC1 CF1 CF2 | 8-21100141 | DX-CBF - Pair of centering cone for van wheels (117-173 mm) with aluminium spacer Ø 40 mm | ★ | ★ | ★ | ★ | ★ | ★ | ★ | ★ | ★ | ★ | ★ | ★ | ★ | ★ | ★ | ★ | ★ | ★ | ★ | ★ |
| | 4-107426 | DX1 - Spacer | | | | | | | | | | | | | | | | | | | | |
| | 4-107423 | CF1 - Cone for vans ø 117÷147 mm | | | | | | | | | | | | | | | | | | | | |
| | 4-107424 | CF2 - Cone for van ø 143÷173 mm | | | | | | | | | | | | | | | | | | | | |
|  ARS DARS | 8-21100089 | ARS - "Racing" accessory for sports wheels, for use with Racing bush | ★ | ★ | ★ | ★ | ★ | ★ | ★ | ★ | ★ | ★ | ★ | ★ | ★ | ★ | ★ | ★ | ★ | ★ | ★ | ★ |
| | 4-105171 | DARS - Spacer 30 mm | | | | | | | | | | | | | | | | | | | | |
|  B16 B17 | 8-21400022 | MERCEDES KIT ø 57/60/66,1/66,42/66,50/67/84 mm | ★ | ★ | ★ | ★ | ★ | ★ | ★ | ★ | ★ | ★ | ★ | ★ | ★ | ★ | ★ | ★ | ★ | ★ | ★ | ★ |
| | 4-138168 | B16 ø 57 / 66,1 / 66,42 / 66,50 / 67 mm | | | | | | | | | | | | | | | | | | | | |
| | 4-138169 | B17 ø 60 / 84 mm | | | | | | | | | | | | | | | | | | | | |

ACCESSORIES FOR CAR WHEEL BALANCERS

| Image | Part-no | Description | MT 3100up | MT 3200up | MT 3200up PLUS | MT 3200C up PLUS | MT 3350up | MT 3350 C up | MT 3600up | MT 3600 C up | MT 3650up | MT 3650 C up | MT 3650up Touchscr | MT 3650 C up Touchscr | MT 3500 up | MT 3500 C up | MT 3800 up | MT 3800 C up | MT 3800 up Touchscr. | MT 3800 C up Touchscr | MT 3900C UP | MT 4000 C UP |
|--|------------|--|-----------|-----------|----------------|------------------|-----------|--------------|-----------|--------------|-----------|--------------|--------------------|-----------------------|------------|--------------|------------|--------------|----------------------|-----------------------|-------------|--------------|
| CENTERING ADAPTORS | | | | | | | | | | | | | | | | | | | | | | |
|  | 8-21100228 | BMW-MINI KIT Ø 66.5, Ø 56.5, Ø 72.5, Ø 74 mm | ★ | ★ | ★ | ★ | ★ | ★ | ★ | ★ | ★ | ★ | ★ | ★ | ★ | ★ | ★ | ★ | ★ | ★ | ★ | ★ |
| | 4-105103 | B6 Ø 66.5 mm | | | | | | | | | | | | | | | | | | | | |
| | 4-105108 | B11 Ø 56.5 - Ø 72.5 - Ø 74 mm | | | | | | | | | | | | | | | | | | | | |
|  | 802459564 | Clamping hood for alloy rims | ★ | ★ | ★ | ★ | ★ | ★ | ★ | ★ | ★ | ★ | ★ | ★ | ★ | ★ | ★ | ★ | ★ | ★ | ★ | ★ |
|  | 8-21100095 | PCD40-40 - Pneumatic quick nut for 40mm shaft | ★ | ★ | ★ | | ★ | | ★ | | ★ | | ★ | | ★ | | ★ | | ★ | | | |



ACCESSORIES FOR CAR WHEEL BALANCERS

| Image | Part-no | Description | MT 3100up | MT 3200up | MT 3200up PLUS | MT 3200C up PLUS | MT 3350up | MT 3350 C up | MT 3600up | MT 3600 C up | MT 3650up | MT 3650 C up | MT 3650up Touchscr | MT 3650 C up Touchscr | MT 3500 up | MT 3500 C up | MT 3800 up | MT 3800 C up | MT 3800 up Touchscr. | MT 3800 C up Touchscr | MT 3900C UP | MT 4000 C UP |
|---|------------|--|-----------|-----------|----------------|------------------|-----------|--------------|-----------|--------------|-----------|--------------|--------------------|-----------------------|------------|--------------|------------|--------------|----------------------|-----------------------|-------------|--------------|
| FLANGES | | | | | | | | | | | | | | | | | | | | | | |
|  <p>per cerchi a 5 fori. Range bloccaggio 95,25 - 180 mm</p> <ul style="list-style-type: none">  Ø 28  Ø 22,5  Ø 22,5  Ø 19 | 8-21100294 | <p>PFM FASTPLATE 5 for 5-hole rims. Clamping range: 95,25 ÷ 180 mm</p> <p>3-05125 PLANETARY GEAR ASSEMBLY 3-05126 TORQUE TIP B Ø28 L:25MM 3-05127 TORQUE TIP C Ø22,5 L:40MM 3-05128 TORQUE TIP C Ø22,5 L:65MM 3-05129 TORQUE TIP E Ø19 L:40MM</p> | ★ | ★ | ★ | ★ | ★ | ★ | ★ | ★ | ★ | ★ | ★ | ★ | ★ | ★ | ★ | ★ | ★ | ★ | ★ | ★ |
|  <p>per cerchi a 3-4-6-8 fori. Range bloccaggio 95,25 - 180 mm</p> <ul style="list-style-type: none">  Ø 28  Ø 22,5  Ø 22,5  Ø 19 | 8-21100295 | <p>PFM FASTPLATE 3-4-6-8 for 3-4-6-8-hole rims. Clamping range: 95,25÷180 mm</p> <p>3-05125 PLANETARY GEAR ASSEMBLY 3-05126 TORQUE TIP B Ø28 L:25MM 3-05127 TORQUE TIP C Ø22,5 L:40MM 3-05128 TORQUE TIP C Ø22,5 L:65MM 3-05129 TORQUE TIP E Ø19 L:40MM</p> | ★ | ★ | ★ | ★ | ★ | ★ | ★ | ★ | ★ | ★ | ★ | ★ | ★ | ★ | ★ | ★ | ★ | ★ | ★ | ★ |
|  <p>8-21100296 PFM FASTPLATE KIT per cerchi a 3-4-5-6-8 fori. Range bloccaggio 95,25 - 180 mm</p> <ul style="list-style-type: none">  Ø 28  Ø 22,5  Ø 22,5  Ø 19 | 8-21100296 | <p>PFM FASTPLATE KIT for 3-4-5-6-8-hole rims. (it includes P/N 8-21100294 and P/N 8-21100295) Clamping range: 95,25÷180 mm</p> <p>3-05125 PLANETARY GEAR ASSEMBLY 3-05126 TORQUE TIP B Ø28 L:25MM 3-05127 TORQUE TIP C Ø22,5 L:40MM 3-05128 TORQUE TIP C Ø22,5 L:65MM 3-05129 TORQUE TIP E Ø19 L:40MM</p> | ★ | ★ | ★ | ★ | ★ | ★ | ★ | ★ | ★ | ★ | ★ | ★ | ★ | ★ | ★ | ★ | ★ | ★ | ★ | ★ |
|  | 8-21100297 | <p>PFM-C SLEEVE HANDLE Sleeve for wheel balancers with automatic clamping. To be screwed directly to the FASTPLATE to work more comfortably and quickly</p> | - | - | - | ★ | - | ★ | - | ★ | - | ★ | - | ★ | - | ★ | - | ★ | - | ★ | ★ | ★ |

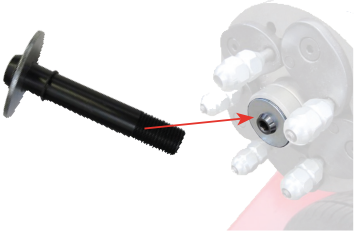

ACCESSORIES FOR CAR WHEEL BALANCERS

| Image | Part-no | Description | MT 3100up | MT 3200up | MT 3200up PLUS | MT 3200C up PLUS | MT 3350up | MT 3350 C up | MT 3600up | MT 3600 C up | MT 3650up | MT 3650 C up | MT 3650up Touchscr | MT 3650 C up Touchscr | MT 3500 up | MT 3500 C up | MT 3800 up | MT 3800 C up | MT 3800 up Touchscr. | MT 3800 C up Touchscr | MT 3900C UP | MT 4000 C UP |
|----------------|------------|---|-----------|-----------|----------------|------------------|-----------|--------------|-----------|--------------|-----------|--------------|--------------------|-----------------------|------------|--------------|------------|--------------|----------------------|-----------------------|-------------|--------------|
| FLANGES | | | | | | | | | | | | | | | | | | | | | | |
| | 8-21100152 | FPF BASIC - Universal flange kit for wheels with central hole | ★ | ★ | ★ | ★ | ★ | ★ | ★ | ★ | ★ | ★ | ★ | ★ | ★ | ★ | ★ | ★ | ★ | ★ | ★ | ★ |
| | 4-109127 | HLT2 - Short cap, ø 22,5 L 58 | | | | | | | | | | | | | | | | | | | | |
| | 4-108097 | PET - Basic Petal | | | | | | | | | | | | | | | | | | | | |
| | 8-21100145 | FPF-2 BMW - BMW flange kit for wheels with central hole - ø 4 x 100 / 5 x 120 / 5 x 112 - | ★ | ★ | ★ | ★ | ★ | ★ | ★ | ★ | ★ | ★ | ★ | ★ | ★ | ★ | ★ | ★ | ★ | ★ | ★ | ★ |
| | 8-21100091 | FRU-SA D.40 - Universal flange for wheels with or without central hole. | ★ | ★ | ★ | ★ | ★ | ★ | ★ | ★ | ★ | ★ | ★ | ★ | ★ | ★ | ★ | ★ | ★ | ★ | ★ | ★ |
| | 2401415 | FT1 Connecting rod with pin | | | | | | | | | | | | | | | | | | | | |
| | 321878 | DEB Conical/spheric nut for wheel fixing | | | | | | | | | | | | | | | | | | | | |
| | 4-105877 | CHT6 T Hexagonal key CH 6 | | | | | | | | | | | | | | | | | | | | |
| | 441286 | RFS Caliper | | | | | | | | | | | | | | | | | | | | |
| | 426517 | CEP Hexagonal key CH 22 | | | | | | | | | | | | | | | | | | | | |
| | 600906 | CHI 6 Hexagonal key CH 6 | | | | | | | | | | | | | | | | | | | | |



ACCESSORIES FOR CAR WHEEL BALANCERS

| Image | Part-no | Description | MT 3100up | MT 3200up | MT 3200up PLUS | MT 3200C up PLUS | MT 3350up | MT 3350 C up | MT 3600up | MT 3600 C up | MT 3650up | MT 3650 C up | MT 3650up Touchscr | MT 3650 C up Touchscr | MT 3500 up | MT 3500 C up | MT 3800 up | MT 3800 C up | MT 3800 up Touchscr. | MT 3800 C up Touchscr | MT 3900C UP | MT 4000 C UP |
|--|------------|---|-----------|-----------|----------------|------------------|-----------|--------------|-----------|--------------|-----------|--------------|--------------------|-----------------------|------------|--------------|------------|--------------|----------------------|-----------------------|-------------|--------------|
| FLANGES | | | | | | | | | | | | | | | | | | | | | | |
|  | 8-21100207 | Locking disc for BVFF bushes for FRU flange, for wheel balancers with manual clamping | ★ | ★ | ★ | | ★ | | ★ | | ★ | | ★ | | ★ | | ★ | | ★ | | | |
|  | 8-21100208 | Locking disc for BVFF bushes for FRU flange, for wheel balancers with automatic "C" clamping | | | | ★ | | ★ | | ★ | | ★ | | ★ | | ★ | | ★ | | ★ | ★ | ★ |
|  <ul style="list-style-type: none"> BF1 BF2 BF3 BF4 BF5 | 8-21100092 | BVFF - Set of five bushes for precise centring on FRU flange | ★ | ★ | ★ | ★ | ★ | ★ | ★ | ★ | ★ | ★ | ★ | ★ | ★ | ★ | ★ | ★ | ★ | ★ | ★ | ★ |
| | 4-105110 | BF1 - Bushing ø 55 Peugeot | | | | | | | | | | | | | | | | | | | | |
| | 4-105174 | BF2 - Bushing ø 58,1 Fiat Ritmo e Citroën CX/Evasion, Peugeot 806 | | | | | | | | | | | | | | | | | | | | |
| | 4-105175 | BF3 - Bushing ø 60,1 Renault | | | | | | | | | | | | | | | | | | | | |
| | 4-105176 | BF4 - Bushing ø 65 Peugeot, Citroën | | | | | | | | | | | | | | | | | | | | |
| | 4-106570 | BF5 - Bushing ø 57 BMW,VW, AUDI, SEAT | | | | | | | | | | | | | | | | | | | | |

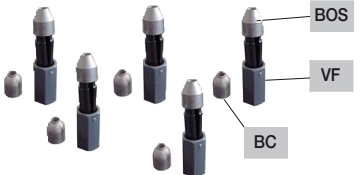

ACCESSORIES FOR CAR WHEEL BALANCERS

| Image | Part-no | Description | MT 3100up | MT 3200up | MT 3200up PLUS | MT 3200C up PLUS | MT 3350up | MT 3350 C up | MT 3600up | MT 3600 C up | MT 3650up | MT 3650 C up | MT 3650up Touchscr | MT 3650 C up Touchscr | MT 3500 up | MT 3500 C up | MT 3800 up | MT 3800 C up | MT 3800 up Touchscr. | MT 3800 C up Touchscr | MT 3900C UP | MT 4000 C UP |
|---|-----------|--|-----------|-----------|----------------|------------------|-----------|--------------|-----------|--------------|-----------|--------------|--------------------|-----------------------|------------|--------------|------------|--------------|----------------------|-----------------------|-------------|--------------|
| FLANGES | | | | | | | | | | | | | | | | | | | | | | |
|  | 802322075 | DCL - Set of five conical nuts for alloy rims with FRU flange | ★ | ★ | ★ | ★ | ★ | ★ | ★ | ★ | ★ | ★ | ★ | ★ | ★ | ★ | ★ | ★ | ★ | ★ | ★ | ★ |
|  | 802322076 | DMS - Set of five spherical nuts for alloy rims with FRU flange | ★ | ★ | ★ | ★ | ★ | ★ | ★ | ★ | ★ | ★ | ★ | ★ | ★ | ★ | ★ | ★ | ★ | ★ | ★ | ★ |
|  | 802231479 | SDR - Set of five special nuts for quick wheel fastening | ★ | ★ | ★ | ★ | ★ | ★ | ★ | ★ | ★ | ★ | ★ | ★ | ★ | ★ | ★ | ★ | ★ | ★ | ★ | ★ |
| | 431481 | BC - Conical bush | | | | | | | | | | | | | | | | | | | | |
| | 431482 | BOS - Spheric bush | | | | | | | | | | | | | | | | | | | | |
| | 431480 | VF - Quick fixing screw | | | | | | | | | | | | | | | | | | | | |

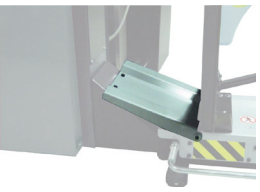





ACCESSORIES FOR CAR WHEEL BALANCERS

| Image | Part-no | Description | MT 3100up | MT 3200up | MT 3200up PLUS | MT 3200C up PLUS | MT 3350up | MT 3350 C up | MT 3600up | MT 3600 C up | MT 3650up | MT 3650 C up | MT 3650up Touchscr | MT 3650 C up Touchscr | MT 3500 up | MT 3500 C up | MT 3800 up | MT 3800 C up | MT 3800 up Touchscr. | MT 3800 C up Touchscr | MT 3900C UP | MT 4000 C UP |
|---|------------|--|-----------|-----------|----------------|------------------|-----------|--------------|-----------|--------------|-----------|--------------|--------------------|-----------------------|------------|--------------|------------|--------------|----------------------|-----------------------|-------------|--------------|
| LIFTERS | | | | | | | | | | | | | | | | | | | | | | |
|  | 8-21100230 | WL-0 Pneumatic wheel lifter. Lifting capacity 80 kg. - Weightless effect - AUTOMATIC | ★ | ★ | ★ | ★ | ★ | ★ | ★ | ★ | ★ | ★ | ★ | ★ | ★ | ★ | ★ | ★ | ★ | ★ | ★ | ★ |
|  | 8-21100248 | WL-R Professional adjustable scissor for wheel lifter. One handed control. MANUAL | ★ | ★ | ★ | ★ | ★ | ★ | ★ | ★ | ★ | ★ | ★ | ★ | ★ | ★ | ★ | ★ | ★ | ★ | ★ | ★ |
| IMAGE NOT AVAILABLE | 8-21100231 | Mounting kit for WL-0 and WL-R | ★ | ★ | ★ | ★ | ★ | ★ | ★ | ★ | ★ | ★ | ★ | ★ | | | | | | | | |
|  | 8-21600132 | Flap kit for WL-0 and WL-R (it allows to mount the lifter on wheel balancers with lateral foot) | ★ | ★ | ★ | ★ | | | ★ | ★ | | | | | | | | | | | | |

ACCESSORIES FOR CAR WHEEL BALANCERS

| Image | Part-no | Description | | MT 3100up | MT 3200up | MT 3200up PLUS | MT 3200C up PLUS | MT 3350up | MT 3350 C up | MT 3600up | MT 3600 C up | MT 3650up | MT 3650 C up | MT 3650up Touchscr | MT 3650 C up Touchscr | MT 3500 up | MT 3500 C up | MT 3800 up | MT 3800 C up | MT 3800 up Touchscr. | MT 3800 C up Touchscr | MT 3900C UP | MT 4000 C UP | | |
|---|------------|---|--|-----------|-----------|----------------|------------------|-----------|--------------|-----------|--------------|-----------|--------------|--------------------|-----------------------|------------|--------------|------------|--------------|----------------------|-----------------------|-------------|--------------|--|--|
| LIFTERS | | | | | | | | | | | | | | | | | | | | | | | | | |
|  | 8-21100161 | WL 80 - Pneumatic wheel lifter. Lifting capacity 80 kg. | | ★ | ★ | ★ | ★ | ★ | ★ | ★ | ★ | ★ | ★ | ★ | ★ | ★ | ★ | ★ | ★ | ★ | ★ | ★ | ★ | | |
|  | 8-21100163 | FTT1 Mounting sets for WL 80 | | ★ | ★ | ★ | ★ | ★ | ★ | ★ | ★ | ★ | ★ | ★ | | | | | | | | | | | |
| | 8-21120002 | FTT2 Mounting sets for WL 80 | | | | | | | | | | | | | ★ | ★ | ★ | ★ | ★ | ★ | ★ | ★ | ★ | | |

ACCESSORIES FOR CAR WHEEL BALANCERS

| Image | Part-no | Description | MT 3100up | MT 3200up | MT 3200up PLUS | MT 3200C up PLUS | MT 3350up | MT 3350 C up | MT 3600up | MT 3600 C up | MT 3650up | MT 3650 C up | MT 3650up Touchscr | MT 3650 C up Touchscr | MT 3500 up | MT 3500 C up | MT 3800 up | MT 3800 C up | MT 3800 up Touchscr. | MT 3800 C up Touchscr | MT 3900C UP | MT 4000 C UP |
|---|------------|--|-----------|-----------|----------------|------------------|-----------|--------------|-----------|--------------|-----------|--------------|--------------------|-----------------------|------------|--------------|------------|--------------|----------------------|-----------------------|-------------|--------------|
| calibration and technical support systems | | | | | | | | | | | | | | | | | | | | | | |
|  | 8-21100221 | SLUG - Calibration tool to retrofit old balancers | ★ | ★ | ★ | ★ | ★ | ★ | ★ | ★ | ★ | ★ | ★ | ★ | ★ | ★ | ★ | ★ | ★ | ★ | ★ | ★ |
|  | 8-21100224 | Serial cable RS232 AMP MODU II to update the firmware of PC board (MBU - MBE - SEB)" - Accessory for Service Centers - | ★ | ★ | ★ | ★ | ★ | ★ | ★ | ★ | ★ | ★ | ★ | ★ | ★ | ★ | ★ | ★ | ★ | ★ | ★ | ★ |
|  | 8-21100225 | Bead depressor clamp | ★ | ★ | ★ | ★ | ★ | ★ | ★ | ★ | ★ | ★ | ★ | ★ | ★ | ★ | ★ | ★ | ★ | ★ | ★ | ★ |
|  | 8-21100226 | Adapter USB-RS232 - To connect USB port onboard of pc and laptop of last generation to RS232 port. - Accessory for Service Centers - | ★ | ★ | ★ | ★ | ★ | ★ | ★ | ★ | ★ | ★ | ★ | ★ | ★ | ★ | ★ | ★ | ★ | ★ | ★ | ★ |
|  | 8-21120001 | Laser calibrator - Accessory for Service Centers - | | | | | | | | | | | | | | | | | | | ★ | ★ |
|  | 802461006 | Adhesive weight remover | ★ | ★ | ★ | ★ | ★ | ★ | ★ | ★ | ★ | ★ | ★ | ★ | ★ | ★ | ★ | ★ | ★ | ★ | ★ | ★ |

ACCESSORIES FOR WHEEL BALANCERS FOR MOTORBIKE

CENTERING AND CLAMPING ACCESSORIES FOR MOTORCYCLE WHEELS

In the range of accessories for off-the-vehicle wheel balancers is now available the new BIKES UNIVERSAL KIT with various additional sets for centering and dynamic balancing of motorcycle wheels.
Easy to install and quickly to use. Ideal for small scooter wheels up to 21 inches large off-road type; without forgetting the wide chopper type and those monolever without bearings.
Balancing results excellent!
Universal for all wheel balancers in range both manual and automatic clamping.

EXAMPLE OF USE



Shaft with centering cones.

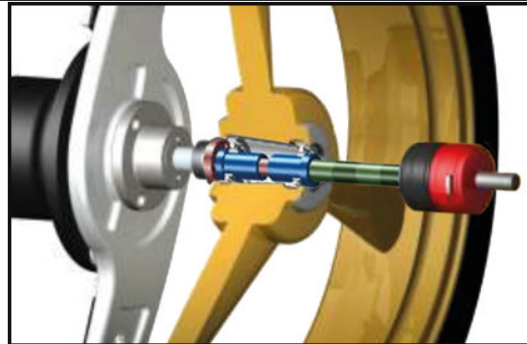

Shaft with centering sleeves.

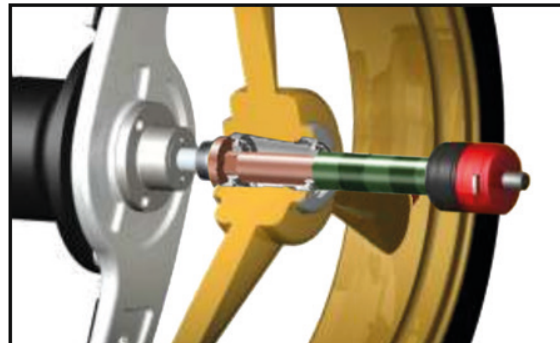

Motorcycle shaft with same diameter as the floating bearing.

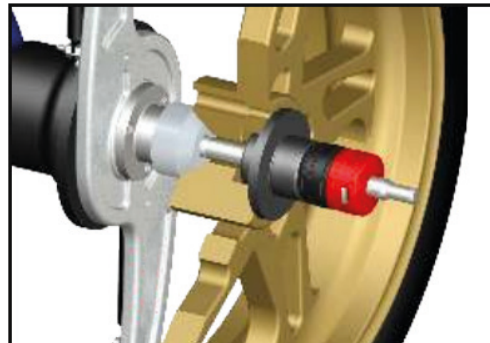

Shaft with special centering kit.

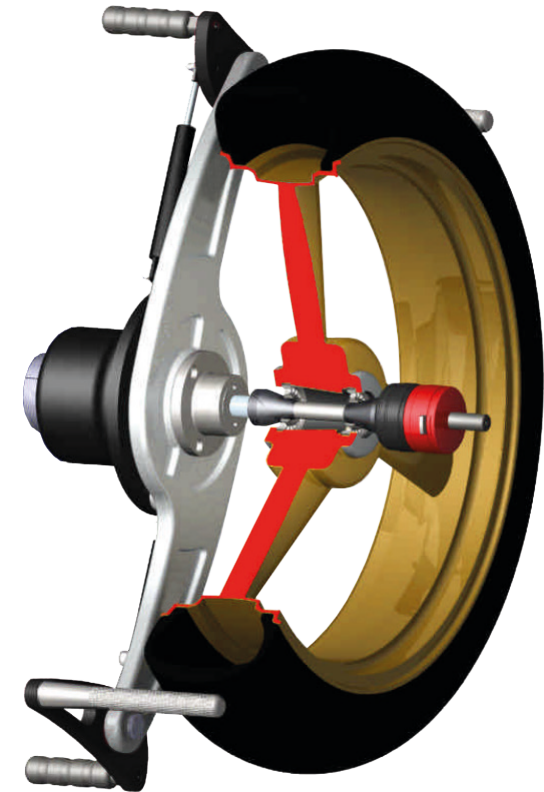

ACCESSORIES FOR MOTORBIKES WHEEL BALANCERS

| Image | Part-no | Description | MT 3100up | MT 3200up | MT 3200up PLUS | MT 3200C up PLUS | MT 3350up | MT 3350 C up | MT 3600up | MT 3600 C up | MT 3650up | MT 3650 C up | MT 3650up Touchscr | MT 3650 C up Touchscr | MT 3500 up | MT 3500 C up | MT 3800 up | MT 3800 C up | MT 3800 up Touchscr. | MT 3800 C up Touchscr | MT 3900C UP | MT 4000 C UP |
|-------|---------|-------------|-----------|-----------|----------------|------------------|-----------|--------------|-----------|--------------|-----------|--------------|--------------------|-----------------------|------------|--------------|------------|--------------|----------------------|-----------------------|-------------|--------------|
|-------|---------|-------------|-----------|-----------|----------------|------------------|-----------|--------------|-----------|--------------|-----------|--------------|--------------------|-----------------------|------------|--------------|------------|--------------|----------------------|-----------------------|-------------|--------------|



ACCESSORIES FOR MOTORCYCLE

| | | | | | | | | | | | | | | | | | | | | | | | | | | | | | | | | | | | | | | | | | | | | | | | | | | | | | | | | | | | | | | | | | | | | | | | | |
|----|-----------------------------------|--|---|----------------|---------|---|-------------------|---------|---|-----------------------------|---------|---|-------------------------|---------|---|----------------------------|---------|---|-------------------------|---------|---|-----------------------------------|---------|---|-----------------------------|---------|---|------------|---------|----|--------------|---------|----|------------------|---------|----|-----------------------------|---------|----|--------------------------|---------|----|--------------------------|---------|----|--------------------------|---------|----|--------------------------|---------|----|--------------------------|---------|--|--|--|--|--|--|--|--|--|--|--|--|--|--|--|--|--|--|--|
| | <p>8-21120012</p> | <p>BIKE UNIVERSAL KIT Basic device for balancing motorcycles and scooters wheels. Wheel holder shaft 14 mm. * Motorcycle extension gauge NOT included</p> <table border="1"> <tr><td>1</td><td>DRAGGING GROUP</td><td>3-03408</td></tr> <tr><td>2</td><td>CYLINDRICAL CHUCK</td><td>3-03409</td></tr> <tr><td>3</td><td>Hexagon socket screw M 6x14</td><td>3-03410</td></tr> <tr><td>4</td><td>Single head wrench SW50</td><td>3-03411</td></tr> <tr><td>5</td><td>Wheel holder shaft Ø 14 mm</td><td>3-03412</td></tr> <tr><td>6</td><td>Centering cone 15÷30 mm</td><td>3-03413</td></tr> <tr><td>7</td><td>Centering cone 16÷45 mm (Scooter)</td><td>3-03414</td></tr> <tr><td>8</td><td>Quick Fix for shaft Ø 14 mm</td><td>3-03415</td></tr> <tr><td>9</td><td>Wall board</td><td>3-03416</td></tr> <tr><td>10</td><td>Short spacer</td><td>3-03417</td></tr> <tr><td>11</td><td>M 14 Knurled nut</td><td>3-03418</td></tr> <tr><td>12</td><td>Hexagon socket head key SW4</td><td>3-03419</td></tr> <tr><td>13</td><td>Centering sleeve Ø 15 mm</td><td>3-03420</td></tr> <tr><td>14</td><td>Centering sleeve Ø 17 mm</td><td>3-03421</td></tr> <tr><td>15</td><td>Centering sleeve Ø 20 mm</td><td>3-03422</td></tr> <tr><td>16</td><td>PIAGGIO Centering sleeve</td><td>3-03423</td></tr> <tr><td>17</td><td>BMW/HONDA Pressure piece</td><td>3-03407</td></tr> </table> | 1 | DRAGGING GROUP | 3-03408 | 2 | CYLINDRICAL CHUCK | 3-03409 | 3 | Hexagon socket screw M 6x14 | 3-03410 | 4 | Single head wrench SW50 | 3-03411 | 5 | Wheel holder shaft Ø 14 mm | 3-03412 | 6 | Centering cone 15÷30 mm | 3-03413 | 7 | Centering cone 16÷45 mm (Scooter) | 3-03414 | 8 | Quick Fix for shaft Ø 14 mm | 3-03415 | 9 | Wall board | 3-03416 | 10 | Short spacer | 3-03417 | 11 | M 14 Knurled nut | 3-03418 | 12 | Hexagon socket head key SW4 | 3-03419 | 13 | Centering sleeve Ø 15 mm | 3-03420 | 14 | Centering sleeve Ø 17 mm | 3-03421 | 15 | Centering sleeve Ø 20 mm | 3-03422 | 16 | PIAGGIO Centering sleeve | 3-03423 | 17 | BMW/HONDA Pressure piece | 3-03407 | | | | | | | | | | | | | | | | | | | |
| 1 | DRAGGING GROUP | 3-03408 | | | | | | | | | | | | | | | | | | | | | | | | | | | | | | | | | | | | | | | | | | | | | | | | | | | | | | | | | | | | | | | | | | | | | | |
| 2 | CYLINDRICAL CHUCK | 3-03409 | | | | | | | | | | | | | | | | | | | | | | | | | | | | | | | | | | | | | | | | | | | | | | | | | | | | | | | | | | | | | | | | | | | | | | |
| 3 | Hexagon socket screw M 6x14 | 3-03410 | | | | | | | | | | | | | | | | | | | | | | | | | | | | | | | | | | | | | | | | | | | | | | | | | | | | | | | | | | | | | | | | | | | | | | |
| 4 | Single head wrench SW50 | 3-03411 | | | | | | | | | | | | | | | | | | | | | | | | | | | | | | | | | | | | | | | | | | | | | | | | | | | | | | | | | | | | | | | | | | | | | | |
| 5 | Wheel holder shaft Ø 14 mm | 3-03412 | | | | | | | | | | | | | | | | | | | | | | | | | | | | | | | | | | | | | | | | | | | | | | | | | | | | | | | | | | | | | | | | | | | | | | |
| 6 | Centering cone 15÷30 mm | 3-03413 | | | | | | | | | | | | | | | | | | | | | | | | | | | | | | | | | | | | | | | | | | | | | | | | | | | | | | | | | | | | | | | | | | | | | | |
| 7 | Centering cone 16÷45 mm (Scooter) | 3-03414 | | | | | | | | | | | | | | | | | | | | | | | | | | | | | | | | | | | | | | | | | | | | | | | | | | | | | | | | | | | | | | | | | | | | | | |
| 8 | Quick Fix for shaft Ø 14 mm | 3-03415 | | | | | | | | | | | | | | | | | | | | | | | | | | | | | | | | | | | | | | | | | | | | | | | | | | | | | | | | | | | | | | | | | | | | | | |
| 9 | Wall board | 3-03416 | | | | | | | | | | | | | | | | | | | | | | | | | | | | | | | | | | | | | | | | | | | | | | | | | | | | | | | | | | | | | | | | | | | | | | |
| 10 | Short spacer | 3-03417 | | | | | | | | | | | | | | | | | | | | | | | | | | | | | | | | | | | | | | | | | | | | | | | | | | | | | | | | | | | | | | | | | | | | | | |
| 11 | M 14 Knurled nut | 3-03418 | | | | | | | | | | | | | | | | | | | | | | | | | | | | | | | | | | | | | | | | | | | | | | | | | | | | | | | | | | | | | | | | | | | | | | |
| 12 | Hexagon socket head key SW4 | 3-03419 | | | | | | | | | | | | | | | | | | | | | | | | | | | | | | | | | | | | | | | | | | | | | | | | | | | | | | | | | | | | | | | | | | | | | | |
| 13 | Centering sleeve Ø 15 mm | 3-03420 | | | | | | | | | | | | | | | | | | | | | | | | | | | | | | | | | | | | | | | | | | | | | | | | | | | | | | | | | | | | | | | | | | | | | | |
| 14 | Centering sleeve Ø 17 mm | 3-03421 | | | | | | | | | | | | | | | | | | | | | | | | | | | | | | | | | | | | | | | | | | | | | | | | | | | | | | | | | | | | | | | | | | | | | | |
| 15 | Centering sleeve Ø 20 mm | 3-03422 | | | | | | | | | | | | | | | | | | | | | | | | | | | | | | | | | | | | | | | | | | | | | | | | | | | | | | | | | | | | | | | | | | | | | | |
| 16 | PIAGGIO Centering sleeve | 3-03423 | | | | | | | | | | | | | | | | | | | | | | | | | | | | | | | | | | | | | | | | | | | | | | | | | | | | | | | | | | | | | | | | | | | | | | |
| 17 | BMW/HONDA Pressure piece | 3-03407 | | | | | | | | | | | | | | | | | | | | | | | | | | | | | | | | | | | | | | | | | | | | | | | | | | | | | | | | | | | | | | | | | | | | | | |
| | <p>8-21100116</p> | <p>Motorcycle wheel distance gauge extensions with clip P/N 8-21100159</p> | | | | | | | | | | | | | | | | | | | | | | | | | | | | | | | | | | | | | | | | | | | | | | | | | | | | | | | | | | | | | | | | | | | | | | |

ACCESSORIES FOR MOTORBIKES WHEEL BALANCERS

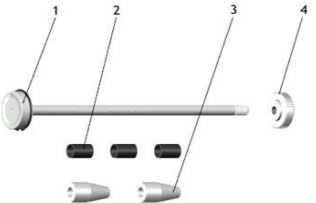

| Image | Part-no | Description | MT 3100up | MT 3200up | MT 3200up PLUS | MT 3200C up PLUS | MT 3350up | MT 3350 C up | MT 3600up | MT 3600 C up | MT 3650up | MT 3650 C up | MT 3650up Touchscr | MT 3650 C up Touchscr | MT 3500 up | MT 3500 C up | MT 3800 up | MT 3800 C up | MT 3800 up Touchscr. | MT 3800 C up Touchscr | MT 3900C UP | MT 4000 C UP |
|-------|---------|-------------|-----------|-----------|----------------|------------------|-----------|--------------|-----------|--------------|-----------|--------------|--------------------|-----------------------|------------|--------------|------------|--------------|----------------------|-----------------------|-------------|--------------|
|-------|---------|-------------|-----------|-----------|----------------|------------------|-----------|--------------|-----------|--------------|-----------|--------------|--------------------|-----------------------|------------|--------------|------------|--------------|----------------------|-----------------------|-------------|--------------|

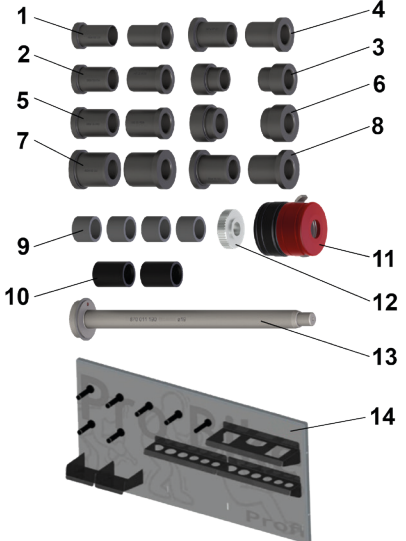
ACCESSORIES FOR MOTORCYCLE

| | | | | | | | | | | | | | | | | | | | | | | | | | | | | | | | | | | | | | | | | | | | | | | | | | | | | | | | | | | | | | | | | | |
|--|-----------------------------|---|---|---------------------------|---------|---|-----------------------------|---------|---|----------------------------|---------|---|---------------------------|---------|---|---------------------------|---------|---|---------------------------|---------|---|---------------------------|---------|---|---------------------------|---------|---|-----------------------|---------|----|---------------------------|---------|----|---------------------------|---------|----|------------------|---------|----|-----------------------------|---------|----|------------|---------|---|---|---|---|---|---|---|---|---|---|---|---|---|---|---|---|---|---|---|---|---|
|  | 8-21100257 | <p>Ø10mm Centering shaft extra-long 230mm, for possible completion of code 8-21120012</p> <table border="1"> <tr> <td>1</td> <td>SHAFT Ø 10 MM</td> <td>3-03864</td> </tr> <tr> <td>2</td> <td>SPACER</td> <td>3-03865</td> </tr> <tr> <td>3</td> <td>CENTERING CONE D. 12÷20 MM</td> <td>3-03866</td> </tr> <tr> <td>4</td> <td>RING NUT M 10</td> <td>3-03867</td> </tr> </table> | 1 | SHAFT Ø 10 MM | 3-03864 | 2 | SPACER | 3-03865 | 3 | CENTERING CONE D. 12÷20 MM | 3-03866 | 4 | RING NUT M 10 | 3-03867 | ★ | ★ | ★ | ★ | ★ | ★ | ★ | ★ | ★ | ★ | ★ | ★ | ★ | ★ | ★ | ★ | ★ | ★ | ★ | ★ | ★ | | | | | | | | | | | | | | | | | | | | | | | | | | | | | | |
| 1 | SHAFT Ø 10 MM | 3-03864 | | | | | | | | | | | | | | | | | | | | | | | | | | | | | | | | | | | | | | | | | | | | | | | | | | | | | | | | | | | | | | | |
| 2 | SPACER | 3-03865 | | | | | | | | | | | | | | | | | | | | | | | | | | | | | | | | | | | | | | | | | | | | | | | | | | | | | | | | | | | | | | | |
| 3 | CENTERING CONE D. 12÷20 MM | 3-03866 | | | | | | | | | | | | | | | | | | | | | | | | | | | | | | | | | | | | | | | | | | | | | | | | | | | | | | | | | | | | | | | |
| 4 | RING NUT M 10 | 3-03867 | | | | | | | | | | | | | | | | | | | | | | | | | | | | | | | | | | | | | | | | | | | | | | | | | | | | | | | | | | | | | | | |
|  | 8-21100155 | Motorcycle wheel distance gauge extensions without clip | ★ | ★ | ★ | ★ | ★ | ★ | ★ | ★ | ★ | ★ | ★ | | | | | | | | | | | | | | | | | | | | | | | | | | | | | | | | | | | | | | | | | | | | | | | | | | | | |
|  | 8-21120013 | <p>BIKE UPGRADE KIT 19 Additional module to BIKE UNIVERSAL KIT.</p> <table border="1"> <tr> <td>1</td> <td>CENTERING SLEEVE D. 22 mm</td> <td>3-03383</td> </tr> <tr> <td>2</td> <td>CENTERING SLEEVE D. 25,4 mm</td> <td>3-03384</td> </tr> <tr> <td>3</td> <td>CENTERING SLEEVE D. 25 mm</td> <td>3-03385</td> </tr> <tr> <td>4</td> <td>CENTERING SLEEVE D. 26 mm</td> <td>3-03386</td> </tr> <tr> <td>5</td> <td>CENTERING SLEEVE D. 28 mm</td> <td>3-03387</td> </tr> <tr> <td>6</td> <td>CENTERING SLEEVE D. 32 mm</td> <td>3-03388</td> </tr> <tr> <td>7</td> <td>CENTERING SLEEVE D. 35 mm</td> <td>3-03389</td> </tr> <tr> <td>8</td> <td>CENTERING SLEEVE D. 30 mm</td> <td>3-03390</td> </tr> <tr> <td>9</td> <td>Short spacer D. 20 mm</td> <td>3-03391</td> </tr> <tr> <td>10</td> <td>HARLEY D. PRESSURE SWITCH</td> <td>3-03392</td> </tr> <tr> <td>11</td> <td>Quick Fix for shaft D. 19</td> <td>3-03393</td> </tr> <tr> <td>12</td> <td>M 14 Knurled nut</td> <td>3-03418</td> </tr> <tr> <td>13</td> <td>Wheel holder shaft D. 19 mm</td> <td>3-03396</td> </tr> <tr> <td>14</td> <td>Wall board</td> <td>3-03395</td> </tr> </table> | 1 | CENTERING SLEEVE D. 22 mm | 3-03383 | 2 | CENTERING SLEEVE D. 25,4 mm | 3-03384 | 3 | CENTERING SLEEVE D. 25 mm | 3-03385 | 4 | CENTERING SLEEVE D. 26 mm | 3-03386 | 5 | CENTERING SLEEVE D. 28 mm | 3-03387 | 6 | CENTERING SLEEVE D. 32 mm | 3-03388 | 7 | CENTERING SLEEVE D. 35 mm | 3-03389 | 8 | CENTERING SLEEVE D. 30 mm | 3-03390 | 9 | Short spacer D. 20 mm | 3-03391 | 10 | HARLEY D. PRESSURE SWITCH | 3-03392 | 11 | Quick Fix for shaft D. 19 | 3-03393 | 12 | M 14 Knurled nut | 3-03418 | 13 | Wheel holder shaft D. 19 mm | 3-03396 | 14 | Wall board | 3-03395 | ★ | ★ | ★ | ★ | ★ | ★ | ★ | ★ | ★ | ★ | ★ | ★ | ★ | ★ | ★ | ★ | ★ | ★ | ★ | ★ | ★ |
| 1 | CENTERING SLEEVE D. 22 mm | 3-03383 | | | | | | | | | | | | | | | | | | | | | | | | | | | | | | | | | | | | | | | | | | | | | | | | | | | | | | | | | | | | | | | |
| 2 | CENTERING SLEEVE D. 25,4 mm | 3-03384 | | | | | | | | | | | | | | | | | | | | | | | | | | | | | | | | | | | | | | | | | | | | | | | | | | | | | | | | | | | | | | | |
| 3 | CENTERING SLEEVE D. 25 mm | 3-03385 | | | | | | | | | | | | | | | | | | | | | | | | | | | | | | | | | | | | | | | | | | | | | | | | | | | | | | | | | | | | | | | |
| 4 | CENTERING SLEEVE D. 26 mm | 3-03386 | | | | | | | | | | | | | | | | | | | | | | | | | | | | | | | | | | | | | | | | | | | | | | | | | | | | | | | | | | | | | | | |
| 5 | CENTERING SLEEVE D. 28 mm | 3-03387 | | | | | | | | | | | | | | | | | | | | | | | | | | | | | | | | | | | | | | | | | | | | | | | | | | | | | | | | | | | | | | | |
| 6 | CENTERING SLEEVE D. 32 mm | 3-03388 | | | | | | | | | | | | | | | | | | | | | | | | | | | | | | | | | | | | | | | | | | | | | | | | | | | | | | | | | | | | | | | |
| 7 | CENTERING SLEEVE D. 35 mm | 3-03389 | | | | | | | | | | | | | | | | | | | | | | | | | | | | | | | | | | | | | | | | | | | | | | | | | | | | | | | | | | | | | | | |
| 8 | CENTERING SLEEVE D. 30 mm | 3-03390 | | | | | | | | | | | | | | | | | | | | | | | | | | | | | | | | | | | | | | | | | | | | | | | | | | | | | | | | | | | | | | | |
| 9 | Short spacer D. 20 mm | 3-03391 | | | | | | | | | | | | | | | | | | | | | | | | | | | | | | | | | | | | | | | | | | | | | | | | | | | | | | | | | | | | | | | |
| 10 | HARLEY D. PRESSURE SWITCH | 3-03392 | | | | | | | | | | | | | | | | | | | | | | | | | | | | | | | | | | | | | | | | | | | | | | | | | | | | | | | | | | | | | | | |
| 11 | Quick Fix for shaft D. 19 | 3-03393 | | | | | | | | | | | | | | | | | | | | | | | | | | | | | | | | | | | | | | | | | | | | | | | | | | | | | | | | | | | | | | | |
| 12 | M 14 Knurled nut | 3-03418 | | | | | | | | | | | | | | | | | | | | | | | | | | | | | | | | | | | | | | | | | | | | | | | | | | | | | | | | | | | | | | | |
| 13 | Wheel holder shaft D. 19 mm | 3-03396 | | | | | | | | | | | | | | | | | | | | | | | | | | | | | | | | | | | | | | | | | | | | | | | | | | | | | | | | | | | | | | | |
| 14 | Wall board | 3-03395 | | | | | | | | | | | | | | | | | | | | | | | | | | | | | | | | | | | | | | | | | | | | | | | | | | | | | | | | | | | | | | | |

ACCESSORIES FOR MOTORBIKES

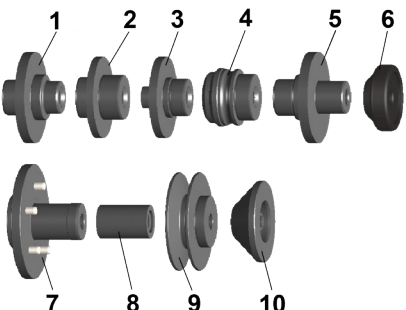
WHEEL BALANCERS

| Image | Part-no | Description | MT 3100up | MT 3200up | MT 3200up PLUS | MT 3200C up PLUS | MT 3350up | MT 3350 C up | MT 3600up | MT 3600 C up | MT 3650up | MT 3650 C up | MT 3650up Touchscr | MT 3650 C up Touchscr | MT 3500 up | MT 3500 C up | MT 3800 up | MT 3800 C up | MT 3800 up Touchscr. | MT 3800 C up Touchscr | MT 3900C UP | MT 4000 C UP | | |
|---|---|---|---|-----------|----------------|------------------|-----------|--------------|-----------|--------------|-----------|--------------|--------------------|-----------------------|------------|--------------|------------|--------------|----------------------|-----------------------|-------------|--------------|---|---|
| ACCESSORIES FOR MOTORCYCLE | | | | | | | | | | | | | | | | | | | | | | | | |
|  | 8-21120014 | BIKE MONOLEVER KIT 19 Additional module to BIKE UPGRADE KIT for motorcycle wheels with monolever. | | | | | | | | | | | | | | | | | | | | | | |
| | | 1 | Centering sleeve ducati/triumph | 3-03397 | | | | | | | | | | | | | | | | | | | | |
| | | 2 | Centering sleeve MV AGUSTA/HONDA | 3-03398 | | | | | | | | | | | | | | | | | | | | |
| | | 3 | Centering sleeve HONDA GL 1800 / NTV 650 | 3-03399 | | | | | | | | | | | | | | | | | | | | |
| | | 4 | Centering sleeve APRILIA/BMW/YAMAHA | 3-03400 | | | | | | | | | | | | | | | | | | | | |
| | | 5 | Centering sleeve TRIUMPH/HONDA VFR1200 | 3-03401 | ★ | ★ | ★ | ★ | ★ | ★ | ★ | ★ | ★ | ★ | ★ | ★ | ★ | ★ | ★ | ★ | ★ | ★ | ★ | ★ |
| | | 6 | PRESSUR PIECE | 3-03402 | | | | | | | | | | | | | | | | | | | | |
| | | 7 | Centering FLANGE KTM SUPERDUKE+ TRIUMPH | 3-03403 | | | | | | | | | | | | | | | | | | | | |
| | | 8 | SPACING SLEEVE, LONG | 3-03404 | | | | | | | | | | | | | | | | | | | | |
| | | 9 | Centering disc BMW II (from year of manufacture 2005) also r v1200 gs | 3-03405 | | | | | | | | | | | | | | | | | | | | |
| 10 | Centering disc BMW I (from year of manufacture 2005) apart r v1200 gs, moto guzzi (FROM 2008) (INTERNAL Ø 14) | 3-03406 | | | | | | | | | | | | | | | | | | | | | | |
|  | 8-21120016 | Ø14mm Centering shaft extra-long 318mm, as possible completion of code 8-21120012 | ★ | ★ | ★ | ★ | ★ | ★ | ★ | ★ | ★ | ★ | ★ | ★ | ★ | ★ | ★ | ★ | ★ | ★ | ★ | ★ | | |
|  | 8-21120017 | Ø19mm Centering shaft extra-long 365mm, as possible completion of code 8-21120013 | ★ | ★ | ★ | ★ | ★ | ★ | ★ | ★ | ★ | ★ | ★ | ★ | ★ | ★ | ★ | ★ | ★ | ★ | ★ | ★ | | |

WHEEL BALANCERS FOR "CAR MOBILE SERVICE"

MT3000 UP - TILT UP HAND SPIN

STANDARD ACCESSORIES

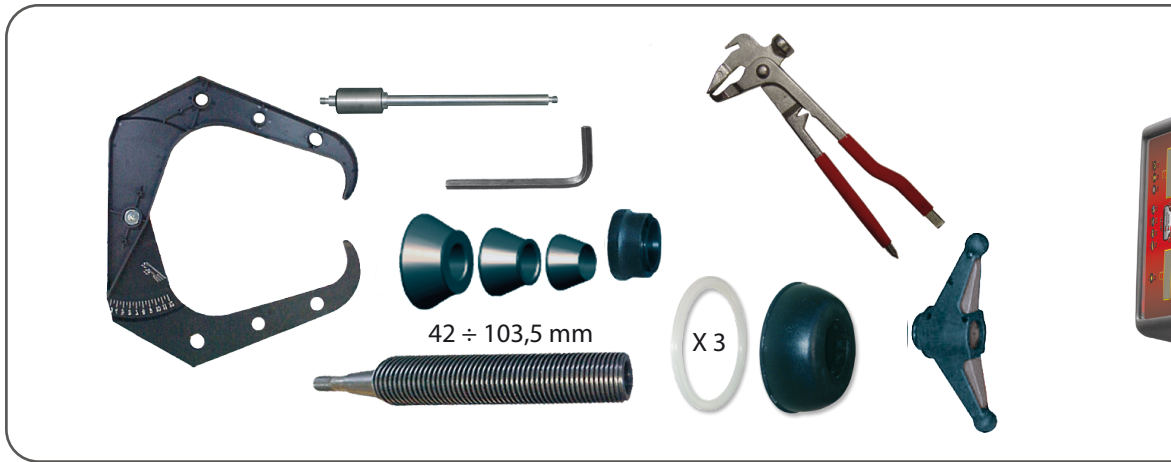

| Part-no | Electrical Supply | Description | |
|---------------|----------------------|---|--|
| 0-21330000/16 | 100-230V/1Ph/50-60Hz | MT3000 UP - TILT UP Hand Spin Special version for mobile service, compact in dimensions and weight. Ideal to work inside the van thanks to the possibility of tilting the measuring unit to vertical position. Manual spin version, AutoSelect automatic wheel size detection. Lever operated brake. | |

WHEEL BALANCERS FOR "CAR MOBILE SERVICE"

MT3000 UP VAN MOTORIZED SPIN

STANDARD ACCESSORIES

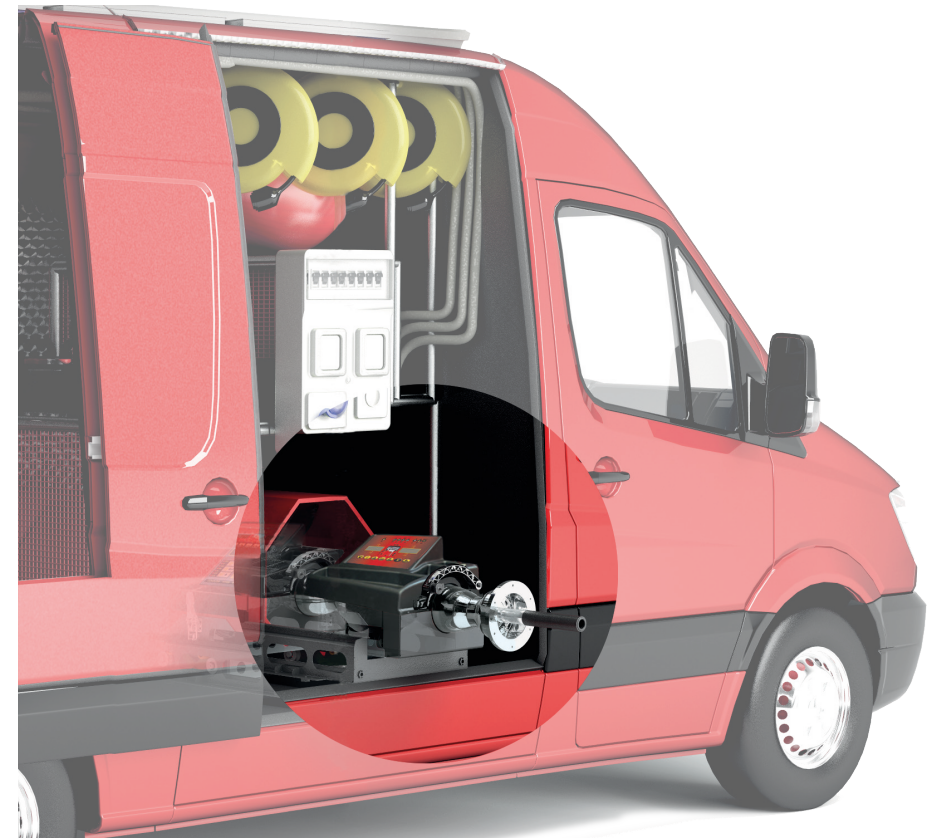
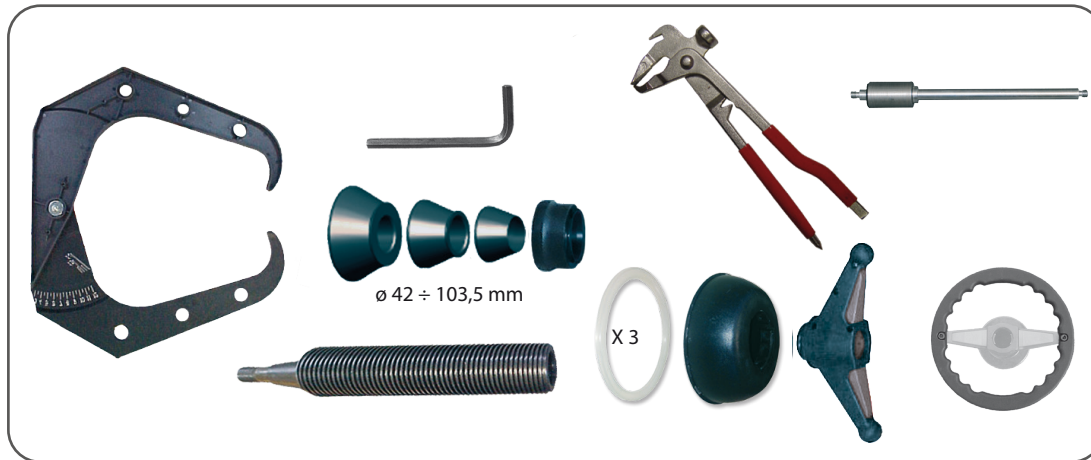

| Part-no | Electrical Supply | Description | |
|---------------|----------------------|--|--|
| 0-21330001/16 | 200-230V/1Ph/50-60Hz | MT3000 UP VAN Motorized Spin Special version for mobile service, compact in dimensions and weight. It can be extracted from the side door and allows working comfortably outside the van. Lever-actuated motorized spin version, AutoSelect automatic wheel size detection. Lever operated brake. | |

WHEEL BALANCERS FOR "CAR MOBILE SERVICE"



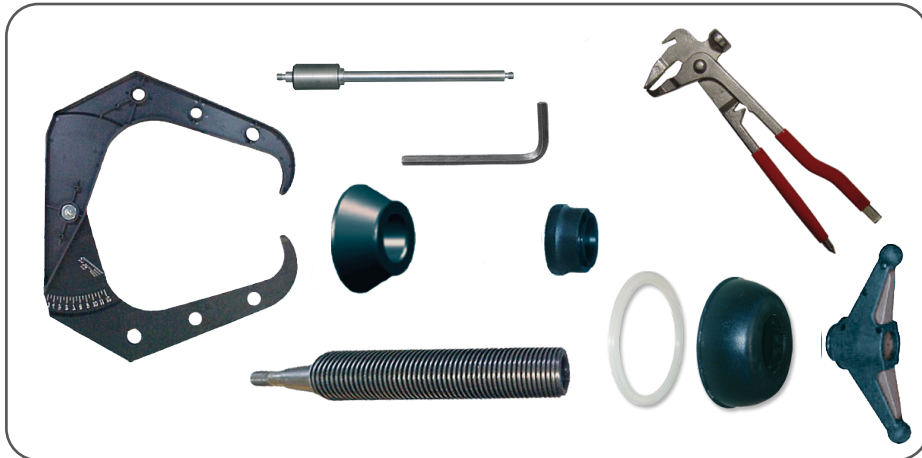

MT3000 UP WORKBENCH HAND SPIN

STANDARD ACCESSORIES



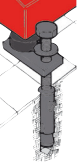

| Part-no | Electrical Supply | Description | |
|---------------|----------------------|---|--|
| 0-21330002/16 | 200-230V/1Ph/50-60Hz | MT3000 Up WORKBENCH - Hand Spin. Extremely compact wheel balancer. it can be fixed to a workbench. For hobbyists, small workshops or for mobile service. AutoSelect 28" automatic wheel size detection. Lever operated brake. Manual spin version. | |

ACCESSORIES WHEEL BALANCERS FOR "CAR MOBILE SERVICE"

| Image | Part-no | Description | | MT 3000 TILT UP | MT 3000 VAN | MT 3000 WB |
|---|---------------|--|--|-----------------|-------------|------------|
|  | 8-21101100/XX | PL -side foot for installation without anchoring to floor; available in red (/16) and grey (/90) color | | ★ | | |
|  | 8-21101200 | Trolley Kit for an easier handling (not for MT3000 UP VAN version) | | ★ | | |
|  | 8-21101000 | AL12 - 12v power supply kit | | ★ | | ★ |
|  | 8-21101010 | KFTU Kit - anchoring kit to floor | | ★ | | |
|  | 8-21120022 | LASER PLANE KIT: Upgrade kit to guide the operator in choosing the rim's inner planes without any errors and with extremely good visibility | | ★ | ★ | ★ |

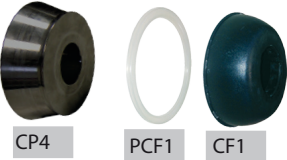
ACCESSORIES WHEEL BALANCERS FOR "CAR MOBILE SERVICE"

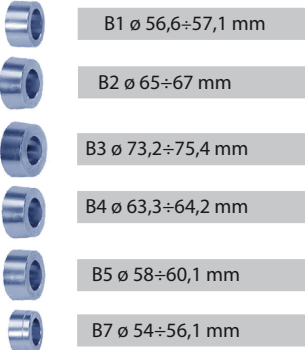
| Image | Part-no | Description | MT 3000 TILT UP | MT 3000 VAN | MT 3000 WB |
|--|------------|--|-----------------|-------------|------------|
|  <p>CP4 PCF1 CF1</p> | 8-21100080 | ARF Accessory for off-road wheels Ø 100 ÷ 118,5 mm, Ø 100 ÷ 129,5 mm | ★ | ★ | ★ |
| | | CGF - Off-road wheel cone (vans) 4-103186 | | | |
| | | PCF1 - Wheel protector for centring alloy rims 4-115868 | | | |
| | | CF1 - Wheel clamping cap 4-115863 | | | |
|  | 8-21100096 | Centering cone capacity from Ø95 to Ø137 mm. | ★ | ★ | ★ |
|  <p>DX1 CF1 CF2</p> | 8-21100141 | DX-CBF - Kit centraggio furgoni e fuoristrada Ø117÷173mm | ★ | ★ | ★ |
| | 4-107426 | X1 - Spacer | | | |
| | 4-107423 | CF1 - Cone for vans ø 117÷147 mm | | | |
| | 4-107424 | CF2 - Cone for van ø 143÷173 mm | | | |
|  <p>B1 ø 56,6÷57,1 mm B2 ø 65÷67 mm B3 ø 73,2÷75,4 mm B4 ø 63,3÷64,2 mm B5 ø 58÷60,1 mm B7 ø 54÷56,1 mm</p> | 8-21100082 | SBC - Serie di 6 boccole centraggio Ø 40 mm | ★ | ★ | ★ |
| | 4-105075 | B1 - Smart (Mercedes), SEAT, Chevrolet, Fiat (Grande Punto), Opel, Audi, Skoda, VW | | | |
| | 4-105076 | B2 - Citroen, Fiat (Scudo), Ford (Transit), Opel, Peugeot, Saab, Volvo, VW, Nissan, Audi (A4), Mercedes, Hyundai, Kia, Mazda, Mitsubishi | | | |
| | 4-105077 | B3 - Aston Martin, BMW (X5, X6), Suzuki (Carry), Jaguar | | | |
| | 4-105078 | B4 - Ford, Jaguar, Mazda (121, Mazda 2), Volvo, Honda, Alfa Romeo | | | |
| | 4-105079 | B5 - Alfa Romeo, Citroen, Fiat, Lancia, Peugeot, Lada, Nissan, Dacia, Renault, Subaru, Toyota | | | |
| | 4-105080 | B7 - Citroen (C1), Daihatsu, Hyundai, Kia, Mazda, Opel (Agila), Peugeot (106, 107), Subaru, Suzuki, Toyota, Honda, Mini (BMW), Proton | | | |

WHEEL BALANCERS FOR "TRUCK MOBILE SERVICE"



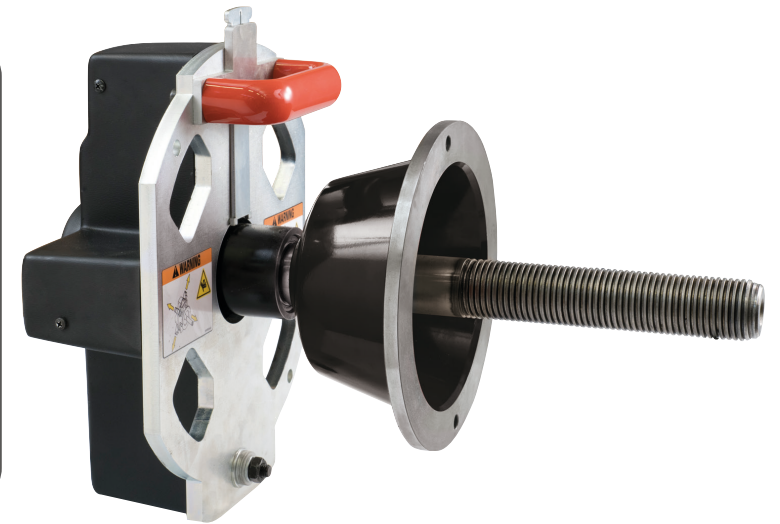

MT6310 MOBILE TRUCK

STANDARD ACCESSORIES



| Part-no | Electrical Supply | Description | |
|---------------|----------------------|--|--|
| 0-21101050/34 | 100-230V/1Ph/50-60Hz | MT6310 MOBILE TRUCK - Portable wheel balancer for truck and bus tyres, compact in dimensions and weight; It can be fit on every type of chuck tyre changer for truck. Specially designed for the mobile service and for workshops having a reduced working space. | |
| 8-21306311 | | Compulsory customizing MT6310 Mobile Truck | |

ACCESSORIES WHEEL BALANCERS FOR "TRUCK MOBILE SERVICE"

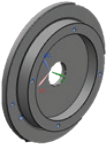
| Image | Part-no | Description | | MT 6310 |
|---|------------|--|--|---------|
|  | 8-21900220 | ART40 - TRUCKS FLANGES CENTERING KIT | | ★ |
|  | 8-21100278 | CAR MATE KIT centering and clamping kit $\varnothing 42\div 103,5$ mm | | ★ |
|  | 8-11100261 | GGR40 Centering kit $\varnothing 40$ for central hole wheels 183,5 \div 223 mm - 17,5"-19.5"rims (IVECO-MAN- DAF) | | ★ |
|  | 8-21101052 | Trolley kit for storage stand | | ★ |
|  | 8-21100267 | DTMS Adapter for mounting truck centering accessories, ART 40 EVO, KCT 40 EVO, and ARV 40 | | ★ |

NEW!

TRUCK WHEEL BALANCERS

MT2450 EASY-ALU

STANDARD ACCESSORIES

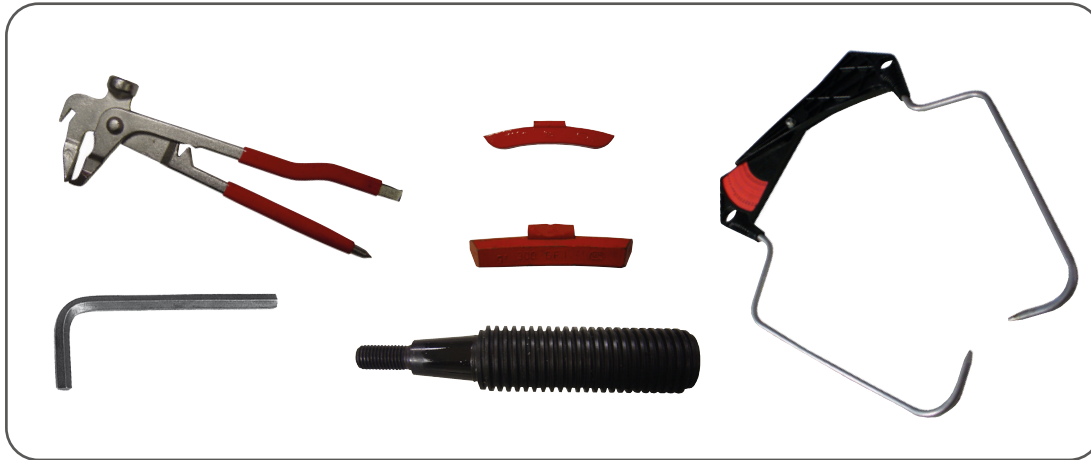

| Part-no | Electrical Supply | Description | |
|---------------|----------------------|---|--|
| 0-21108401/16 | 200-230V/1Ph/50-60Hz | MT2450 EASY-ALU - LED display, motorized machine for truck wheels with automatic data input, including wheel lifter and wheel guard. | |
| 0-21108402/16 | 100-115V/1Ph/50-60Hz | As above, with different power supply | |

TRUCK WHEEL BALANCERS

MT2650 EASY-ALU

STANDARD ACCESSORIES

Monitor not included

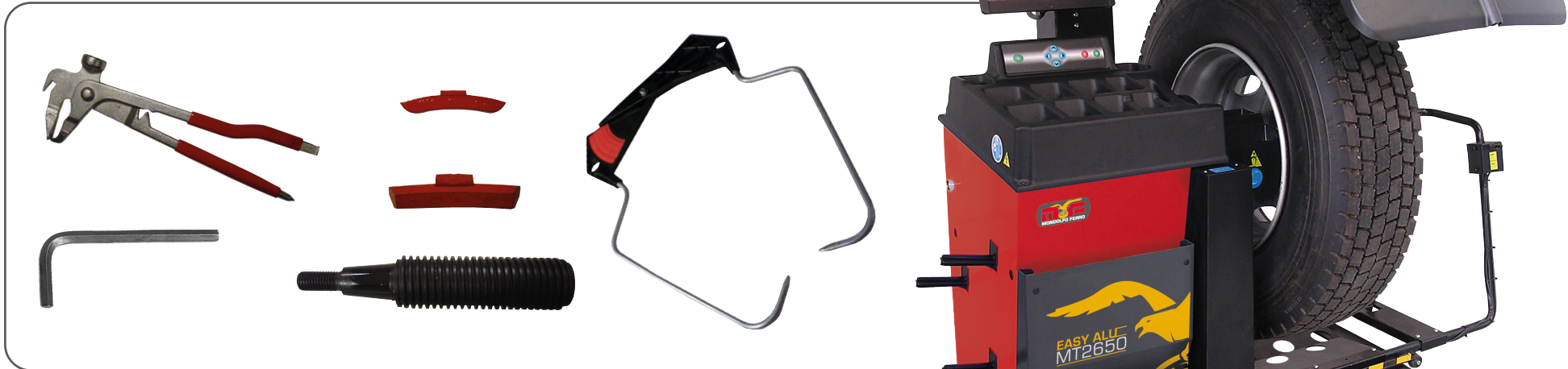

| Part-no | Electrical Supply | Description | |
|---------------|----------------------|--|--|
| 0-21108301/16 | 200-230V/1Ph/50-60Hz | MT2650 EASY-ALU - Motorized machine for truck wheels with automatic data input, including wheel lifter and wheel guard. | |

TRUCK WHEEL BALANCERS

MT6350

STANDARD ACCESSORIES



cod.
802227308



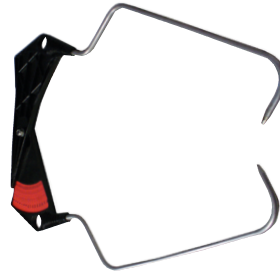

cod.
238304





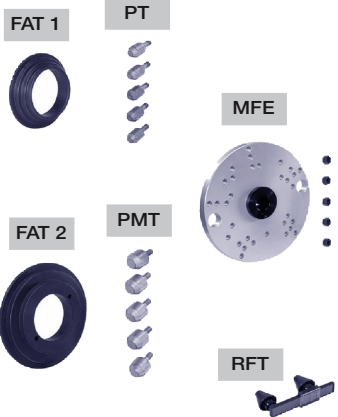

| Part-no | Electrical Supply | Description | |
|---------------|----------------------|---|--|
| 0-21306350/16 | 200-230V/1Ph/50-60Hz | MT6350 MO Motorised Spin Version - Compact motorized truck/bus balancer, Automatic Gauge 28", AWC, automatic brake at the end of the spin; Inverter Technology System; integrated wheel lift | |
| 0-21306352/16 | 100-115V/1Ph/50-60Hz | MT6350 MO Motorised Spin Version - as above but in different voltage | |
| 0-21306351/16 | 100-230V/1Ph/50-60Hz | MT6350 HS Hand Spin Version - Compact handspin truck/bus balancer, Automatic Gauge 28", AWC, manual brake, integrated wheel lift | |



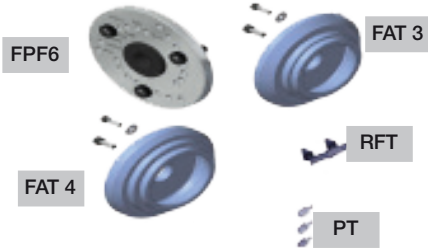

ACCESSORIES FOR TRUCK WHEEL BALANCERS

| Image | Part-no | Description | | MT 6350 MO | MT 6350 HS | MT 2450 | MT 2650 |
|---|------------|---|--|------------|------------|---------|---------|
| MONITOR | | | | | | | |
|  | 8-21100235 | 19" wide screen monitor | | | | | ★ |
| CENTERING ADAPTORS | | | | | | | |
|  | 8-21100269 | ART40 EVO - Premium Heavy-Duty adaptor Kit (10-8-6 hole) Support flange for truck rims with central hole $\varnothing 160/176/200$ mm Support flange for truck rims with central hole $\varnothing 220/280$ mm Pcd: 6 x 205 / 6 x 222 / 6 x 245 / 8 x 275 / 8 x 285 / 10 x 335 / 10 x 285,75 / 10 x 225 | | ★ | ★ | | |
|  | 8-21100268 | KCT40 EVO - Heavy-Duty cone Kit Medium double sided cone, $\varnothing 159 \div 180 / 198 \div 204$ mm Large double sided cone, $\varnothing 220-281$ mm | | ★ | ★ | | |





ACCESSORIES FOR TRUCK WHEEL BALANCERS

| Image | Part-no | Description | MT 6350 MO | MT 6350 HS | MT 2450 | MT 2650 |
|---|------------|---|------------|------------|---------|---------|
|  | 8-21100270 | ARV40 - Premium Medium&Light commercial vehicle adaptor kit (6-hole) MERCEDES : SPRINTER VW : LT 35 / 40 / 46 FORD : TRANSIT IVECO : DAILY NISSAN : NV 400 OPEL : MOVANO 2 RENAULT : MASTER | ★ | ★ | | |
|  | 8-21100261 | GGR40 Centering kit \varnothing 40 for central hole wheels 183,5÷223 mm - 17,5"-19,5"rims (IVECO-MAN- DAF) | ★ | ★ | | |
|  | 8-21100141 | DX-CBF Centring accessory for vans and off-road wheels \varnothing 117÷173 mm | ★ | ★ | | |
|  | 8-21900191 | ARU40 \varnothing 42÷156 mm (1.65"÷6,14") - recessed spring included | ★ | ★ | | |
|  | 8-21100284 | CBG-2 Alloy wheel clamping cup (\varnothing 220 mm). Suits GTR40 EVO quick nut | ★ | ★ | | |



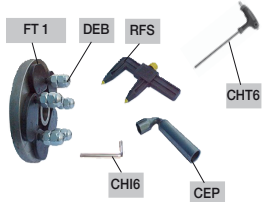

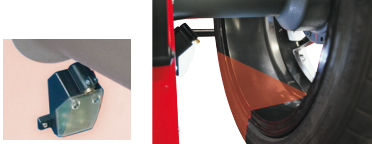
ACCESSORIES FOR TRUCK WHEEL BALANCERS

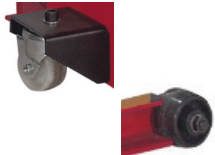
| Image | Part-no | Description | | MT 6350 MO | MT 6350 HS | MT 2450 | MT 2650 |
|---|------------|--|--|------------|------------|---------|---------|
|  | 8-21100275 | GTR40 EVO PRO - Steel quick nut Ø 40x4 mm | | ★ | | | |
|  | 8-21100276 | GTR40 EVO - Quick nut Ø 40x4 mm | | ★ | | | |
|  | 8-21100279 | GTR40 EVO HS - Quick nut Ø 40x4 mm with turning handles | | | ★ | | |
|  | 8-21900194 | GTV40 - Ring nut Ø 40x4 mm | | ★ | | | |
|  | 8-21100272 | GTM40 - Ring nut Ø 40x4 mm | | | ★ | | |



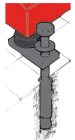
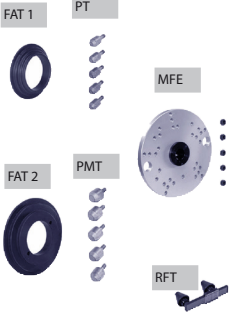

ACCESSORIES FOR TRUCK WHEEL BALANCERS

| Image | Part-no | Description | | MT 6350 MO | MT 6350 HS | MT 2450 | MT 2650 |
|---|---|--|--|------------|------------|---------|---------|
|  | 8-21100091 2401415 321878 4-105877 441286 426517 600906 | FRU-SA D.40 - Universal flange for wheels with or without central hole. FT1 Connecting rod with pin DEB Conical/spheric nut for wheel fixing CHT6 T Hexagonal key CH 6 RFS Caliper CEP Hexagonal key CH 22 CHI 6 Hexagonal key CH 6 | | ★ | ★ | | |
|  | 8-21100290 | TWS40 Truck wheel spacer Ø 40 (30mm - 1.19") | | ★ | ★ | | |
|  | 8-21101000 | AL12 - 12v power supply kit | | | ★ | | |
|  | 8-21100238 | Laser & Led kit | | ★ | ★ | | |
|  | 8-21120022 | LASER PLANE KIT: Upgrade kit to guide the operator in choosing the rim's inner planes without any errors and with extremely good visibility | | ★ | ★ | | |
|  | 8-21101400 | TRUCK TROLLEY KIT for an easier handling | | ★ | ★ | | |





ACCESSORIES FOR TRUCK WHEEL BALANCERS

| Image | Part-no | Description | | MT 6350 MO | MT 6350 HS | MT 2450 | MT 2650 |
|---|------------|--|--|------------|------------|---------|---------|
|  | 8-21101401 | ROLL-BAR KIT - lateral protection | | ★ | ★ | | |
|  | 8-21101402 | ACCESSORY RACK | | ★ | ★ | ★ | ★ |
|  | 8-21101010 | KFTU Kit - anchoring kit to floor | | ★ | ★ | | |
|  | 802239637 | ART - Professional centring accessory for truck wheels. FAT 1 -Support flange for truck rims with hole ø160/176/200 mm FAT 2 - Support flange for truck rims with hole ø220/280 mm PT - Pin for centring truck wheels with ø18-35 mm fastener screw holes PMT - MAXI pin for centring truck wheels with ø28-47 mm fastener screw holes MFE - Hub with flange RFT - Hole detector for measuring truck wheel fastener hole distance | | | | ★ | ★ |
|  | 802245159 | KCT - Basic centring accessory for truck wheels | | | | ★ | ★ |
| | 345160 | DBT - Double sided truck wheel support spacer flange | | | | | |
| | 345161 | CT 161 - Medium double sided cone, ø159 ÷180 / 198 ÷204 mm | | | | | |
| | 345162 | CT 221 Large double sided cone, ø220-281 mm | | | | | |

ACCESSORIES FOR TRUCK WHEEL BALANCERS

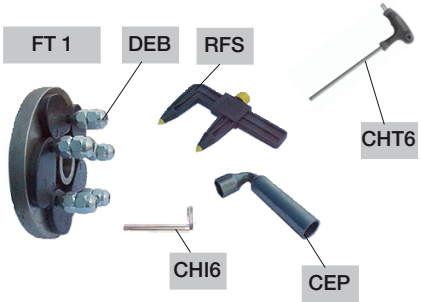
| Image | Part-no | Description | | MT 6350 MO | MT 6350 HS | MT 2450 | MT 2650 |
|--|------------|--|--|------------|------------|---------|---------|
|  <div style="display: flex; justify-content: space-around; width: 100%;"> DPT CGT </div> | 802247716 | ARFT - Centring accessory for off-road and van wheels. | | | | ★ | ★ |
| | 341843 | DPT Van wheel support spacer flange | | | | | |
| | 339672 | CGT Large double sided cone, ø110-165 mm | | | | | |
|  | 8-21100222 | GGR 223 , Accessory for centre hole wheels from Ø 190 to 223 mm (rims Ø 17,5-19,5") IVECO - MAN - DAF | | | | ★ | ★ |
|  <div style="display: flex; justify-content: space-around; width: 100%;"> DFT </div> | 802245527 | DFT - Spacer for FORD F350/450 wheels for use with ARFT | | | | ★ | ★ |
|  <div style="display: flex; justify-content: space-around; width: 100%;"> FTA CMT CPT </div> | 802247782 | ARU - Basic centering accessory for car wheels | | | | ★ | ★ |
| | 339673 | FTA Flange for reducing passenger car wheel support diameter | | | | | |
| | 339670 | CPT Small cone, ø47-64 mm | | | | | |
| | 802443938 | GTR - Quick clamping ring for truck and passenger car wheels, Ø 46 | | | | ★ | ★ |
|  | 802239121 | GTV - Basic ring for clamping truck and passenger car wheels, Ø 46 (manual spin) | | | | ★ | ★ |

ACCESSORIES FOR TRUCK WHEEL BALANCERS

| ACCESSORIES FOR TRUCK WHEEL BALANCERS | | | | MT 6350 MO | MT 6350 HS | MT 2450 | MT 2650 |
|---|---------------|---|--|------------|------------|---------|---------|
| Image | Part-no | Description | | | | | |
|  | 8-21100256 | FRU-SA D.46 - Universal flange for car and industrial vehicle wheels 3-4-5-6 holes (without central hole). Distance between holes \varnothing min. 90 max. 210 mm. | | | | ★ | ★ |
| | 4-135110 | FT 1 Connecting rod with pin | | | | | |
| | 4-105877 | CHT6 T-Hexagonal wrench CH6 | | | | | |
| | 321878 | DEB DOUBLE SIDED (conical and spherical) nut for fastening wheels | | | | | |
| | 600906 | CHI6 Hexagonal wrench CH6 | | | | | |
| | 441286 | RFS Hole detector for measuring wheel fastener hole distance | | | | | |
| | 426517 | CEP Hex-headed elbow wrench CH22 | | | | | |
|  | 802244344 | Hand spin handle to be used with cod. 8-21100091 | | | ★ | | |
| MISCELLANEOUS | | | | | | | |
|  | 802461006 | Adhesive weight remover | | ★ | ★ | ★ | ★ |
|  | 8-21100298/90 | TWG Wheel guard kit with support. | | ★ | | | |

NEW!

AUTOMOTIVE SERVICE EQUIPMENT



www.facebook.com/MONDOLFOFERROofficial/



<http://www.youtube.com/user/MondolfoFerro>

NEXION S.p.A.
Viale Dell'Industria, 20 - 61037 MONDOLFO (PU) ITALY
Tel. 0721.93671 - Telefax 0721.930232
info@mondolfoferro.it - www.mondolfoferro.it

